

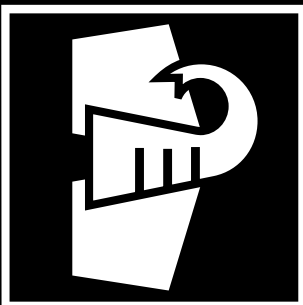

WEBRU



Prefacio

Preface

Prefácio

**Werku proporciona
herramientas de calidad
al precio correcto, sin
renunciar al diseño y la
innovación tecnológica.
Con esta simple filosofía,
cada día más usuarios
compran Werku.**

Werku provides quality tools
at the right price, without
giving up design and
technological innovation.
With this simple philosophy,
every day more users
buy Werku.

Werku fornece ferramentas de
qualidade a um preço justo,
sem comprometer o desenho
e a inovação tecnológica.
Com esta filosofia simples,
todos os dias mais usuários
compram Werku.

Contenido

Contents

Contido

Herramientas eléctricas

Herramientas neumáticas y airless

Herramientas manuales

Escaleras y plataformas

Protección y seguridad

Químicos técnicos

Power tools

Pneumatic and airless tools

Hand tools

Ladders and platforms

Protection and safety

Technical chemicals

Ferramentas elétricas

Ferramentas pneumáticas e airless

Ferramentas manuais

Escadas e plataformas

Proteção e segurança

Químicos técnicos

Herramientas eléctricas

Power tools

Ferramentas elétricas



Lijadora circular paredes-techos

Circular wall-ceiling sander

Lixadora circular paredes-tetos

Cuerpo de ABS y acero carbono

Interruptor con botón de funcionamiento continuo

Sistema de extracción compatible con aspirador

Agarre ergonómico antideslizante

Mango auxiliar

Selector de velocidades

Sistema de luz LED 360° integrado

Fijación con velcro

Extensible

Plegable

Incluye disco microperforado de lijado

Incluye manguera de aspiración de 4.5 metros

Incluye bolsa de transporte

ABS and carbon steel body

Switch with continuous operation button

Extraction system compatible with vacuum cleaner

Ergonomic non-slip grip

Auxiliary handle

Speed selector

Integrated 360° LED light system

Velcro fixing

Extendable

Foldable

Includes microperforated sanding disc

Includes 4.5-meter suction hose

Includes transportation bag

Corpo de ABS e aço carbono

Interruptor com botão de operação contínua

Sistema de extracção compatible com aspirador

Agarramento ergonómico antiderrapante

Cabo auxiliar

Selector de velocidades

Sistema de luz LED 360° integrado

Fixação com velcro

Extensível









Dobrável

Inclui disco microperforado de lixado

Inclui manguera de sucção de 4.5 metros

Inclui bolsa de transporte



	WK400030 2 / 001-124.000
	750 W
	1000-2100 RPM
	6
	225 MM
	1300-1800 MM
	0-45°
	CE
	8 424835 003487

Lijadora circular paredes-techos

Circular wall-ceiling sander

Lixadora circular paredes-tetos

Cuerpo de ABS y acero carbono

Interruptor con botón de funcionamiento continuo

Sistema de extracción integrado (compatible con aspirador)

Agarre ergonómico antideslizante

Mango auxiliar

Selector de velocidades

Sistema de luz LED 360° integrado

Fijación con velcro

Extensible

Plegable

Incluye disco microperforado de lijado

Incluye manguera de aspiración de 1.5 metros

Incluye bolsa reutilizable colectora de polvo de 20 litros

Incluye correa de uso

Incluye bolsa de transporte

ABS and carbon steel body

Continuous operation switch

Integrated extraction system (compatible with vacuum cleaner)

Ergonomic non-slip grip

Auxiliary handle

Speed selector

Integrated 360° LED light system

Velcro fixing

Extendable

Foldable

Includes microperforated sanding disc

Includes 1.5-meter suction hose

Includes 20 liters reusable dust collection bag

Includes use belt

Includes transportation bag

Corpo de ABS e aço carbono

Interruptor de operação contínua

Sistema de extração integrado (compatible com aspirador)

Agarramento ergonômico antiderrapante

Cabo auxiliar

Selector de velocidades

Sistema de luz LED 360° integrado

Fixação com velcro

Extensível

Dobrável

Inclui disco microperforado de lixado

Inclui mangueira de sucção de 1.5 metros

Inclui bolsa reutilizável coletora de pó de 20 litros

Inclui correia de uso

Inclui bolsa de transporte



	WK403070 2 / 001-139.000
	750 W
	1000-1850 RPM
	6
	225 MM
	1300-1800 MM
	0-45°
	CE
	8 424835 001216

Lijadora circular paredes-techos

Circular wall-ceiling sander

Lixadora circular paredes-tetos

Cuerpo de ABS y aluminio

Motor sin escobillas

Interruptor con botón de funcionamiento continuo

Sistema de extracción compatible con aspirador

Agarre ergonómico antideslizante

Mango auxiliar

Selector de velocidades

Sistema de luz LED 360° integrado

Fijación con velcro

Extensible

Plegable

Incluye disco microperforado de lijado

Incluye manguera de aspiración de 4.5 metros

Incluye bolsa de transporte

ABS and aluminium body

Brushless motor

Switch with continuous operation button

Extraction system compatible with vacuum cleaner

Ergonomic non-slip grip

Auxiliary handle

Speed selector

Integrated 360° LED light system

Velcro fixing

Extendable

Foldable

Includes microperforated sanding disc

Includes 4.5-meter suction hose

Includes transportation bag

Corpo de ABS e alumínio

Motor sem escovas

Interruptor com botão de operação contínua

Sistema de extracção compatible com aspirador

Agarramento ergonómico antiderrapante

Cabo auxiliar

Selector de velocidades

Sistema de luz LED 360° integrado

Fixação com velcro

Extensível









Dobrável

Inclui disco microperforado de lixado

Inclui mangueria de sucção de 4.5 metros

Inclui bolsa de transporte



	WK403260 1 / 001-189.000
	400 W
	900-2100 RPM
	7
	225 MM
	1200-1800 MM
	0-45°
	CE / GS
	8 424835 010294

Lijadora circular paredes-techos hormigón

Circular concrete wall-ceiling sander

Lixadora circular paredes-tetos concreto

Cuerpo de ABS y aluminio

Sistema de extracción compatible con aspirador

Interruptor de funcionamiento continuo

Agarre ergonómico antideslizante

Mango auxiliar orientable

Selector de velocidades

Extensible

Incluye disco de diamante

Incluye manguera de aspiración de 3.8 metros

ABS and aluminium body

Extraction system compatible with vacuum cleaner

Continuous operation switch

Ergonomic non-slip grip

Adjustable auxiliary handle

Speed selector

Extendable

Includes diamond disc

Includes 3.8-meter suction hose

Corpo de ABS e alumínio

Sistema de extracção compatible com aspirador

Interruptor de operação contínua

Agarramento ergonómico antiderrapante

Cabo auxiliar orientável











Selector de velocidades

Extensível

Inclui disco de diamante

Inclui manguera de sucção de 3.8 metros



	WK400210 2 / 001-174.000
	1000 W
	1700-3500 RPM
	7
	125 X 22 MM
	M-14
	1100-1700 MM
	0-45°
	CE
	8 424835 007294

Lijadora circular paredes

Circular wall sander

Lixadora circular paredes

Cuerpo de ABS

Interruptor con botón de funcionamiento continuo

Sistema de extracción integrado (compatible con aspirador)

Agarre ergonómico antideslizante

Mango con protector de puño

Mango auxiliar de 2 posiciones

Selector de velocidades

Sistema de luz LED 360° integrado

Fijación con velcro

Incluye disco microperforado de lijado

Incluye manguera de aspiración de 1.5 metros

Incluye bolsa reutilizable colectora de polvo de 20 litros

Incluye correa de uso

ABS body

Switch with continuous operation button

Integrated extraction system (compatible with vacuum cleaner)

Ergonomic non-slip grip

Fist protector handle

2-position auxiliary handle

Speed selector

Integrated 360° LED light system

Velcro fixing

Includes microperforated sanding disc

Includes 1.5-meter suction hose

Includes 20 liters reusable dust collection bag

Includes use belt

Corpo de ABS

Interruptor com botão de operação contínua

Sistema de extracção integrado (compatible with asp

Agarramento ergonómico antiderrapante

Cabo com protector de punho

Cabo auxiliar de 2 posições

Selector de velocidades

Sistema de luz LED 360° integrado

Fixação com velcro







Inclui disco microperforado de lixado

Inclui mangueira de sucção de 1.5 metros

Inclui bolsa reutilizável colectora de pó de 20 litros

Inclui correia de uso



	WK403250 2 / 001-078.000
	1200 W
	1500-2600 RPM
	6
	225 MM
	CE
	8 424835 003531

Lijadora circular paredes

Circular wall sander

Lixadora circular paredes

Cuerpo de ABS

Interruptor con botón de funcionamiento continuo

Sistema de extracción integrado (compatible con aspirador)

Agarre ergonómico antideslizante

Mango auxiliar

Selector de velocidades

Sistema de luz LED 360° integrado

Fijación con velcro

Incluye disco microperforado de lijado

Incluye manguera de aspiración de 1.5 metros

Incluye bolsa reutilizable colectora de polvo de 20 litros

Incluye correa de uso

ABS body

Switch with continuous operation button

Integrated extraction system (compatible with vacuum cleaner)

Ergonomic non-slip grip

Auxiliary handle

Speed selector

Integrated 360° LED light system

Velcro fixing

Includes microperforated sanding disc

Includes 1.5-meter suction hose

Includes 20 liters reusable dust collection bag

Includes use belt

Corpo de ABS

Interruptor com botão de operação contínua

Sistema de extracção integrado (compatible com aspirador)

Agarramento ergonómico antiderrapante

Cabo auxiliar

Selector de velocidades

Sistema de luz LED 360° integrado

Fixação com velcro

Inclui disco microperforado de lixado

Inclui mangueria de sucção de 1.5 metros

Inclui bolsa reutilizável colectora de pó de 20 litros

Inclui correia de uso



	WK403300 2 / 001-094.000
	1200 W
	1000-1950 RPM
	6
	225 MM
	CE
	8 424835 010720

Cepillo paredes hormigón

Concrete wall planer

Plaina paredes concreto

Cuerpo de ABS y aluminio

Sistema de extracción compatible con aspirador

Agarre ergonómico antideslizante

Mango con protector de puño

Mango auxiliar

Incluye disco de cuchilla de diamante

Incluye manguera de aspiración de 1.5 metros

Incluye maletín de transporte

ABS and aluminium body

Extraction system compatible with vacuum cleaner

Ergonomic non-slip grip

Fist protector handle

Auxiliary handle

Includes diamond blade disc

Includes 1.5-meter suction hose

Includes transportation case

Corpo de ABS e alumínio

Sistema de extracção compatible com aspirador

Agarramento ergonómico antiderrapante

Cabo com protector de punho









Cabo auxiliar

Inclui disco de lâmina de diamante

Inclui manguera de sucção de 1.5 metros

Inclui mala de transporte



	WK401100 1 / 001-168.000
	1200 W
	9600 RPM
	50 MM
	0-3.5 MM
	52 MM
	CE
	8 424835 008222

Lijadora circular paredes hormigón

Circular concrete wall sander

Lixadora circular paredes concreto

Cuerpo de ABS y acero carbono

Sistema de extracción compatible con aspirador

Agarre ergonómico antideslizante

Mango auxiliar

Selector de velocidades

Incluye disco de diamante

ABS and carbon steel body

Extraction system compatible with vacuum cleaner

Ergonomic non-slip grip

Auxiliary handle

Speed selector

Includes diamond disc

Corpo de ABS e aço carbono

Sistema de extracção compatible com aspirador









Agarramento ergonómico antiderrapante

Cabo auxiliar

Selector de velocidades

Inclui disco de diamante



	WK400200 2 / 001-128.000
	1500 W
	2500-4500 RPM
	7
	125 X 22 MM
	M-14
	CE
	8 424835 007287

Lijadora-pulidora circular paredes mortero-yeso

Circular mortar-drywall sander-polisher

Lixadora-polidora circular paredes argamassa-gesso

Cuerpo de ABS y aluminio

Interruptor con botón de funcionamiento continuo

Agarre ergonómico antideslizante

Mango auxiliar

Selector de velocidades

Incluye disco esponja

Incluye disco rascado

Incluye disco talocha

Incluye disco de lijado

ABS and aluminium body

Switch with continuous operation button

Ergonomic non-slip grip

Auxiliary handle

Speed selector

Includes sponge disc

Includes scraper disc

Includes trowel disc

Includes sanding disc

Corpo de ABS e alumínio

Interruptor com botão de operação contínua

Agarramento ergonômico antiderrapante

Cabo auxiliar

Selector de velocidades









Inclui disco esponja

Inclui disco rascador

Inclui disco talocha

Inclui disco de lixado



	WK401090 1 / 001-132.000
	710 W
	60-110 RPM
	6
	390 MM
	M-6
	CE
	8 424835 008215

Sierra circular mármol-piedra

Marble-stone circular saw

Serra circular mármore-pedra

Cuerpo de ABS y aluminio

Interruptor con botón de funcionamiento continuo

Agarre ergonómico antideslizante

Mango con protector de puño

Sistema de refrigeración con agua

Base graduable

Incluye disco de corte

Incluye manguera de suministro de agua

ABS and aluminium body

Switch with continuous operation button

Ergonomic non-slip grip

Fist protector handle

Water cooling system

Adjustable base

Includes cutting disc

Includes water supply hose

Corpo de ABS e alumínio

Interruptor com botão de operação contínua

Agarramento ergonômico antiderrapante

Cabo com protector de punho









Sistema de refrigeração com água

Base graduável

Inclui disco de corte

Inclui mangueira de abastecimento de água



	WK400740 4 / 001-049.000
	1250 W
	13800 RPM
	110/125 X 20 MM
	0 - 30/40 MM
	M-6
	45°
	CE
	8 424835 009526

Rozadora paredes

Wall chaser

Roçadora paredes

Cuerpo de ABS y aluminio

Sistema de extracción integrado (compatible con aspirador)

Agarre ergonómico antideslizante

Mango auxiliar

Sistema de refrigeración con agua

Incluye disco de corte de triple hoja

Incluye bolsa reutilizable colectora de polvo

Incluye manguera de aspiración de 1 metro

Incluye maletín de transporte

ABS and aluminium body

Integrated extraction system (compatible with vacuum cleaner)

Ergonomic non-slip grip

Auxiliary handle

Water cooling system

Includes triple blade cutting disc

Includes reusable dust collection bag

Includes 1-meter suction hose

Includes transportation case

Corpo de ABS e alumínio

Sistema de extracção integrado (compatible com aspirador)

Agarramento ergonómico antiderrapante

Cabo auxiliar

Sistema de refrigeração com água









Inclui disco de corte de tripla folha

Inclui bolsa reutilizável colectora de pó

Inclui mangueira de sucção de 1 metro

Inclui mala de transporte



	WK403230 2 / 001-178.000
	2400 W
	8000 RPM
	150 X 22 MM
	M-8
	8-43 MM
	28 MM
	CE
	8 424835 009052

Aspirador seco-húmedo

Dry-wet vacuum cleaner

Aspirador seco-úmido

Cuerpo de ABS

Tanque de aluminio

Ruedas de polipropileno de 50 mm

Ruedas orientables en 360 grados

Interruptor de funcionamiento continuo

Doble filtrado mediante bolsa de polvo y filtro HEPA

Función de sincronización con herramientas eléctricas

Función de soplado de aire

Cadena anti-electrostática

Incluye accesorios de limpieza

Incluye manguera de aspiración de 1.5 metros

Incluye bolsa reutilizable colectora de polvo

Incluye filtro HEPA para sólidos

Incluye filtro esponja para líquidos

ABS body

Aluminium tank

Polypropylene wheels of 50 mm

Adjustable wheels in 360 degrees

Continuous operation switch

Double filtering by dust bag and HEPA filter

Power tool synchronization function

Air blow function

Anti-electrostatic chain

Includes cleaning accessories

Includes 1.5-meter suction hose

Includes reusable dust collection bag

Includes HEPA filter for solids

Includes sponge filter for liquids

Corpo de ABS

Tanque de alumínio

Rodas de polipropileno de 50 mm

Rodas ajustáveis em 360 graus

Interruptor de operação contínua

Duplo filtragem através de saco de pó e filtro HEPA

Função de sincronização com ferramentas elétricas

Função soprado de ar

Cadeia anti-eletróstática

Inclui acessórios de limpeza









Inclui mangueira de sucção de 1.5 metros

Inclui bolsa reutilizável colectora de pó

Inclui filtro HEPA para sólidos

Inclui filtro esponja para líquidos



	WK402010 1 / 001-084.000	WK402020 1 / 001-092.000
	1200 W	1200 W
	20 L	30 L
	3500 LPM	3500 LPM
	180 MBAR	180 MBAR
	≤ 2000 W	≤ 2000 W
	CE	CE
	8 424835 007218	8 424835 007225

Aspirador seco-húmedo

Dry-wet vacuum cleaner

Aspirador seco-úmido

Cuerpo de ABS

Tanque de aluminio

Ruedas de PVC de 63 y 150 mm

Ruedas orientables en 360 grados

Asa de transporte

Interruptor de funcionamiento continuo

Doble filtrado mediante bolsa de polvo y filtro HEPA

Función de sincronización con herramientas eléctricas

Función de soplado de aire

Cadena anti-electrostática

Incluye accesorios de limpieza

Incluye manguera de aspiración de 1.5 metros

Incluye bolsa reutilizable colectora de polvo

Incluye filtro HEPA para sólidos

Incluye filtro esponja para líquidos

ABS body

Aluminium tank

PVC wheels of 63 and 150 mm

Adjustable wheels in 360 degrees

Carrying handle

Continuous operation switch

Double filtering by dust bag and HEPA filter

Power tool synchronization function

Air blow function

Anti-electrostatic chain

Includes cleaning accessories

Includes 1.5-meter suction hose

Includes reusable dust collection bag

Includes HEPA filter for solids

Includes sponge filter for liquids

Corpo de ABS

Tanque de alumínio

Rodas de PVC de 63 e 150 mm

Rodas ajustáveis em 360 graus

Alça de transporte

Interruptor de operação contínua

Duplo filtragem através de saco de pó e filtro HEPA

Função de sincronização com ferramentas elétricas

Função soprado de ar

Cadeia anti-eletrostática

Inclui acessórios de limpeza









Inclui mangueira de sucção de 1.5 metros

Inclui bolsa reutilizável colectora de pó

Inclui filtro HEPA para sólidos

Inclui filtro esponja para líquidos



	WK402030 1 / 001-152.000	WK403310 1 / 001-164.000
	1400 W	1400 W
	50 L	60 L
	3500 LPM	3500 LPM
	180 MBAR	180 MBAR
	≤ 2000 W	≤ 2000 W
	CE	CE
	8 424835 007232	8 424835 010607

Aspirador seco-húmedo

Dry-wet vacuum cleaner

Aspirador seco-úmido

Cuerpo de ABS

Tanque de polipropileno/PVC

Ruedas de caucho de 50 mm y de polipropileno/PVC de 150 mm

Ruedas delanteras orientables en 360 grados

Asa de transporte acolchada de caucho

Interruptor de funcionamiento continuo

Triple filtrado mediante bolsa de polvo, depósito de agua y filtro HEPA

Regulador de potencia

Función de sincronización con herramientas eléctricas

Función de soplado de aire

Función de limpieza rápida del filtro

Incluye accesorios de limpieza

Incluye manguera de aspiración de 2 metros

Incluye 2 bolsas reutilizables colectoras de polvo

Incluye filtro HEPA para sólidos

Incluye filtro esponja para líquidos

ABS body

Polypropylene/PVC tank

Rubber wheels of 50 mm and polypropylene/PVC wheels of 150 mm

Adjustable front wheels in 360 degrees

Rubber padded carrying handle

Continuous operation switch

Triple filtering by dust bag, water tank and HEPA filter

Power regulator

Power tool synchronization function

Air blow function

Filter quick clean function

Includes cleaning accessories

Includes 2-meter suction hose

Includes 2 reusable dust collection bags

Includes HEPA filter for solids

Includes sponge filter for liquids

Corpo de ABS

Tanque de polipropileno/PVC

Rodas de borracha de 50 mm e de polipropileno/PVC de 150 mm

Rodas dianteiras ajustáveis em 360 graus

Alça de transporte acolchoada de borracha

Interruptor de operação contínua

Tripla filtração através de saco de pó, tanque de água e filtro HEPA

Regulador de potência

Função de sincronização com ferramentas elétricas

Função soprado de ar

Função de limpeza rápida do filtro

Inclui acessórios de limpeza









Inclui mangueira de sucção de 2 metros

Inclui 2 bolsas reutilizáveis colectoras de pó

Inclui filtro HEPA para sólidos

Inclui filtro esponja para líquidos



	WK401450 1 / 001-222.000
	1600 W
	30 L
	3700 LPM
	180 MBAR
	≤ 2000 W
	CE
	8 424835 010065

Bolsa polvo aspirador
Vacuum cleaner dustbag
 Saco pó aspirador

Cuerpo de polipropileno SMS
Reutilizable
Lavable

SMS polypropylene body
 Reusable
 Washable

Corpo de polipropileno SMS
 Reutilizável
 Lavável



WK402010
WK402020
WK402030
WK403310
WK401450



	WK300530 5 / 001-006.600	WK300540 5 / 001-008.800
	20-30 L	50-60 L
	450 MM	580 MM
	280 MM	330 MM
	36-61 MM	36-61 MM
PCS	2	2
	CE	CE
	8 424835 010614	8 424835 010621

Mezclador

Mixer

Misturador

Cuerpo de ABS y aluminio

Interruptor con botón de funcionamiento continuo

Agarre ergonómico antideslizante

Mango auxiliar de 3 posiciones

Regulador de velocidad

Función de rotación reversible

Incluye varilla mezcladora

ABS and aluminium body

Switch with continuous operation button

Ergonomic non-slip grip

3-position auxiliary handle

Speed regulator

Reversible rotation function

Includes mixer stirrer

Corpo de ABS e alumínio

Interruptor com botão de operação contínua

Agarramento ergonômico antiderrapante











Cabo auxiliar de 3 posições

Regulador de velocidade

Função de rotação reversível

Inclui varilha misturadora



	WK403140 4 / 001-058.000
	1050 W
	0-580 RPM
	45 NM
	M-14
	120 MM
	600 MM
	50 KG
	CE
	8 424835 505059

Mezclador

Mixer

Misturador

Cuerpo de ABS y aluminio

Interruptor con botón de funcionamiento continuo

Agarre ergonómico antideslizante

Selector de velocidades

Selector de 2 rangos de revoluciones

Incluye varilla mezcladora

ABS and aluminium body

Switch with continuous operation button

Ergonomic non-slip grip

Speed selector

2-speed range selector

Includes mixer stirrer

Corpo de ABS e alumínio

Interruptor com botão de operação contínua











Agarramento ergonômico antiderrapante

Selector de velocidades

Selector de 2 níveis de rotações

Inclui varilha misturadora



	WK400130 2 / 001-078.000	WK401710 2 / 001-088.000
	1600 W	1800 W
	180-400/300-700 RPM	180-400/300-700 RPM
	12	12
	60 NM	70 NM
	M-14	M-14
	140 MM	140 MM
	600 MM	600 MM
	75 KG	100 KG
	CE	CE
	8 424835 001339	8 424835 010737

Mezclador inalámbrico

Cordless mixer

Misturador sem fios

Cuerpo de ABS y aluminio

Motor sin escobillas

Interruptor con botón de funcionamiento continuo

Agarre ergonómico antideslizante

Selector de velocidades

Selector de 2 rangos de revoluciones

Incluye varilla mezcladora

Incluye 2 baterías

ABS and aluminium body

Brushless motor

Switch with continuous operation button

Ergonomic non-slip grip

Speed selector

2-speed range selector

Includes mixer stirrer

Includes 2 batteries

Corpo de ABS e alumínio

Motor sem escovas

Interruptor com botão de operação contínua

Agarramento ergonómico antiderrapante

Selector de velocidades

Selector de 2 níveis de rotações

Inclui varilha misturadora

Inclui 2 baterias



	WK403280 2 / 001-208.000
	20V = 4.0 AH LI-ION
	2 H
	250-400/350-650 RPM
	10
	60 NM
	M-14
	120 MM
	600 MM
	75 KG
	CE
	8 424835 010744

Mezclador doble

Double mixer

Misturador duplo

Cuerpo de ABS y aluminio

Interruptor con botón de funcionamiento continuo

Agarre ergonómico antideslizante

Selector de velocidades

Selector de 2 rangos de revoluciones

Incluye 2 varillas mezcladoras

ABS and aluminium body

Switch with continuous operation button

Ergonomic non-slip grip

Speed selector

2-speed range selector

Includes 2 mixer stirrers

Corpo de ABS e alumínio

Interruptor com botão de operação contínua











Agarramento ergonômico antiderrapante

Selector de velocidades

Selector de 2 níveis de rotações

Inclui 2 varilhas misturadoras



	WK403240 2 / 001-108.000
	1600 W
	200-480/250-680 RPM
	12
	70 NM
	HEX-13
	120 MM
	550 MM
	100 KG
	CE
	8 424835 007980

Varilla mezclador

Mixer stirrer

Varinha misturador

Cuerpo de acero galvanizado

Juntas reforzadas con soldadura TIG

Conexión hexagonal para taladros

Compatible con mezclas de viscosidad baja

Dirección de fluido hacia abajo

Galvanized steel body

Reinforced TIG welding joints

Hexagonal connection for drills

Compatible with low viscosity mixtures

Downwards fluid direction

Corpo de aço galvanizado







Juntas reforçadas com soldadura TIG

Conexão hexagonal para berbequims

Compatível com misturas de viscosidade baixa

Direção do fluido para baixo



	WK602210 12 / 006-002.200	WK602220 12 / 006-002.400	WK602230 12 / 006-004.400	WK602240 12 / 006-004.600
	HEX-8	HEX-8	HEX-9	HEX-9
	60 MM	80 MM	100 MM	120 MM
	400 MM	400 MM	600 MM	600 MM
	5-10 KG	5-15 KG	10-25 KG	15-30 KG
	8 424835 001421	8 424835 001155	8 424835 002497	8 424835 001162

Varilla mezclador

Mixer stirrer

Varinha misturador

Cuerpo de acero galvanizado

Juntas reforzadas con soldadura TIG

Conexión hexagonal para taladros

Compatible con mezclas de viscosidad media

Dirección de fluido hacia arriba

Galvanized steel body

Reinforced TIG welding joints

Hexagonal connection for drills

Compatible with medium viscosity mixtures

Upwards fluid direction

Corpo de aço galvanizado

Juntas reforçadas com soldadura TIG

Conexão hexagonal para berbequims

Compatível com misturas de viscosidade média

Direção do fluido para cima



	WK602100 6 / 001-004.600	WK602110 6 / 001-005.200
	HEX-8	HEX-8
	100 MM	120 MM
	600 MM	600 MM
	10-25 KG	15-30 KG
	8 424835 510022	8 424835 002855

Varilla mezclador

Mixer stirrer

Varinha misturador

Cuerpo de acero galvanizado

Juntas reforzadas con soldadura TIG

Conexión hexagonal para taladros

Compatible con mezclas de viscosidad alta

Dirección de fluido hacia arriba

Galvanized steel body

Reinforced TIG welding joints

Hexagonal connection for drills

Compatible with high viscosity mixtures

Upwards fluid direction

Corpo de aço galvanizado

Juntas reforçadas com soldadura TIG

Conexão hexagonal para berbequims

Compatível com misturas de viscosidade alta

Direção do fluido para cima



	WK602080 6 / 001-006.000	WK602090 6 / 001-006.600
	HEX-9	HEX-9
	100 MM	120 MM
	600 MM	600 MM
	10-25 KG	15-30 KG
	8 424835 006631	8 424835 006648

Varilla mezclador

Mixer stirrer

Varinha misturador

Cuerpo de acero galvanizado

Juntas reforzadas con soldadura TIG

Conexión métrica para mezcladores

Compatible con mezclas de viscosidad media

Dirección de fluido lateral

Galvanized steel body

Reinforced TIG welding joints

Metric connection for mixers

Compatible with medium viscosity mixtures

Lateral fluid direction

Corpo de aço galvanizado







Juntas reforçadas com soldadura TIG

Conexão métrica para misturadores

Compatível com misturas de viscosidade média

Direção do fluido lateral



	WK602550 6 / 001-007.400	WK602560 6 / 001-008.000
	M-14	M-14
	120 MM	140 MM
	600 MM	600 MM
	15-30 KG	15-60 KG
	8 424835 010706	8 424835 010713

Varilla mezclador

Mixer stirrer

Varinha misturador

Cuerpo de acero galvanizado

Juntas reforzadas con soldadura TIG

Conexión métrica para mezcladores

Compatible con mezclas de viscosidad media

Dirección de fluido hacia arriba

Galvanized steel body

Reinforced TIG welding joints

Metric connection for mixers

Compatible with medium viscosity mixtures

Upwards fluid direction

Corpo de aço galvanizado







Juntas reforçadas com soldadura TIG

Conexão métrica para misturadores

Compatível com misturas de viscosidade média

Direção do fluido para cima



	WK602010 6 / 001-007.600	WK602020 6 / 001-008.200
	M-14	M-14
	120 MM	140 MM
	600 MM	600 MM
	15-30 KG	15-60 KG
	8 424835 001018	8 424835 003869

Varilla mezclador

Mixer stirrer

Varinha misturador

Cuerpo de acero galvanizado

Juntas reforzadas con soldadura TIG

Conexión métrica para mezcladores

Compatible con mezclas de viscosidad alta

Dirección de fluido hacia arriba

Galvanized steel body

Reinforced TIG welding joints

Metric connection for mixers

Compatible with high viscosity mixtures

Upwards fluid direction

Corpo de aço galvanizado





Juntas reforçadas com soldadura TIG

Conexão métrica para misturadores

Compatível com misturas de viscosidade alta

Direção do fluido para cima



	WK602030 6 / 001-009.000	WK602040 6 / 001-009.600
	M-14	M-14
	120 MM	140 MM
	600 MM	600 MM
	15-30 KG	15-60 KG
	8 424835 006655	8 424835 006662

Pistola pintar succión HVLP-I

HVLP-I suction paint spray gun

Pistola pintar sucção HVLP-I

Cuerpo de ABS

Agarre ergonómico antideslizante

Cabezal de liberación rápida

Cabezal intercambiable

Control de abanico

Regulador de fluido

Incluye viscosímetro

ABS body

Ergonomic non-slip grip

Quick release head

Interchangeable head

Pattern control

Fluid spray regulator

Includes viscometer

Corpo de ABS

Agarramento ergonômico antiderrapante

Cabeçal de liberação rápida

Cabeçal intercambiável

Controle de leque

Regulador de fluido











Inclui viscosímetro



HVLP-I (alto volumen a baja presión) reduce el consumo del producto a pulverizar un 30%, acorta el tiempo de trabajo un 20%, disminuye el consumo de aire un 15% y genera una buena calidad de pulverización y acabado.

HVLP-I (high volume at low pressure) reduces the consumption of the product to be sprayed by 30%, shortens the working time by 20%, reduces air consumption by 15% and generates a good quality of spray and finish.

HVLP-I (alto volumen a baixa pressão) reduz o consumo do produto a ser pulverizado em 30%, reduz o tempo de trabalho em 20%, reduz o consumo de ar em 15% e gera uma boa qualidade de pulverização e acabamento.

	WK401200 6 / 001-042.000
	500 W
	0.4 BAR
	1.4 BAR
	1.8 / 2.6 MM
	80 DIN SEC
	800 ML
	800 ML MIN
	CE
	8 424835 007669

Pistola pintar succión turbina HVLP-I

HVLP-I turbine suction paint spray gun

Pistola pintar sucção turbina HVLP-I

Cuerpo de ABS

Agarre ergonómico antideslizante

Cabezal de liberación rápida

Cabezal intercambiable

Control de abanico

Regulador de fluido

Incluye viscosímetro

Incluye correa de uso

Incluye manguera de 1.8 metros

ABS body

Ergonomic non-slip grip

Quick release head

Interchangeable head

Pattern control

Fluid spray regulator

Includes viscometer

Includes use belt

Includes 1.8-meter hose

Corpo de ABS

Agarramento ergonômico antiderrapante

Cabeçal de liberação rápida

Cabeçal intercambiável

Controle de leque

Regulador de fluido

Inclui viscosímetro

Inclui correia de uso











Inclui mangueira de 1.8 metros



HVLP-I (alto volumen a baja presión) reduce el consumo del producto a pulverizar un 30%, acorta el tiempo de trabajo un 20%, disminuye el consumo de aire un 15% y genera una buena calidad de pulverización y acabado.

HVLP-I (high volume at low pressure) reduces the consumption of the product to be sprayed by 30%, shortens the working time by 20%, reduces air consumption by 15% and generates a good quality of spray and finish.

HVLP-I (alto volumen a baixa pressão) reduz o consumo do produto a ser pulverizado em 30%, reduz o tempo de trabalho em 20%, reduz o consumo de ar em 15% e gera uma boa qualidade de pulverização e acabamento.

	WK401210 2 / 001-058.000
	650 W
	0.4 BAR
	1.4 BAR
	1.8 / 2.6 MM
	80 DIN SEC
	800 ML
	800 ML MIN
	CE
	8 424835 007676

Pistola pintar succión turbina-trolley HVLP-I

HVLP-I turbine-trolley suction paint spray gun

Pistola pintar sucção turbina-trolley HVLP-I

Cuerpo de ABS

Ruedas de ABS de 130 mm

Agarre ergonómico antideslizante

Asa extensible

Cabezal de liberación rápida

Cabezal intercambiable

Control de abanico

Regulador de fluido

Incluye viscosímetro

Incluye manguera de 3 metros

ABS body

ABS wheels of 130 mm

Ergonomic non-slip grip

Extendable handle

Quick release head

Interchangeable head

Pattern control

Fluid spray regulator

Includes viscometer

Includes 3-meter hose

Corpo de ABS

Rodas de ABS de 130 mm

Agarramento ergonómico antiderrapante

Alça extensível

Cabeçal de liberação rápida

Cabeçal intercambiável

Controle de leque

Regulador de fluido

Inclui viscosímetro

Inclui mangueira de 3 metros



HVLP-I (alto volumen a baja presión) reduce el consumo del producto a pulverizar un 30%, acorta el tiempo de trabajo un 20%, disminuye el consumo de aire un 15% y genera una buena calidad de pulverización y acabado.

HVLP-I (high volume at low pressure) reduces the consumption of the product to be sprayed by 30%, shortens the working time by 20%, reduces air consumption by 15% and generates a good quality of spray and finish.

HVLP-I (alto volumen a baixa pressão) reduz o consumo do produto a ser pulverizado em 30%, reduz o tempo de trabalho em 20%, reduz o consumo de ar em 15% e gera uma boa qualidade de pulverização e acabamento.

	WK401180 2 / 001-070.000
	750 W
	0.4 BAR
	1.4 BAR
	1.8 / 2.6 MM
	80 DIN SEC
	800 ML
	800 ML MIN
	CE
	8 424835 007652

Pistola aire caliente

Hot air gun

Pistola ar quente

Cuerpo de ABS

Interruptor de funcionamiento continuo

Agarre ergonómico antideslizante

Mango con protector de puño

Selector de velocidades

Incluye 6 accesorios de rascado

Incluye maletín de transporte

ABS body

Continuous operation switch

Ergonomic non-slip grip

Fist protector handle

Speed selector

Includes 6 scraper accessories

Includes transportation case

Corpo de ABS

Interruptor de operação contínua

Agarramento ergonômico antiderrapante

Cabo com protector de punho

Selector de velocidades

Inclui 6 acessórios de raspagem

Inclui mala de transporte



Pistola aire caliente

Hot air gun

Pistola ar quente

Cuerpo de ABS

Interruptor de funcionamiento continuo

Agarre ergonómico antideslizante

Mango con protector de puño

Control gradual de la temperatura

Selector de velocidades

Incluye 6 accesorios de rascado

Incluye maletín de transporte

ABS body

Continuous operation switch

Ergonomic non-slip grip

Fist protector handle

Gradual temperature control

Speed selector

Includes 6 scraper accessories

Includes transportation case

Corpo de ABS

Interruptor de operação contínua

Agarramento ergonômico antiderrapante

Cabo com protector de punho

Controle gradual da temperatura

Selector de velocidades

Inclui 6 acessórios de raspagem

Inclui mala de transporte



	WK402060 10 / 001-022.000
	2000 W
	300-500 LPM
	2
	350-600° C
	CE
	8 424835 007461

	WK402070 10 / 001-030.000
	2000 W
	300-500 LPM
	3
	50-600° C
	CE
	8 424835 007645

Pistola aire caliente digital

Digital hot air gun

Pistola ar quente digital

Cuerpo de ABS

Interruptor de funcionamiento continuo

Agarre ergonómico antideslizante

Mango con protector de puño

Control gradual de la temperatura

Selector de velocidades

Display digital

Incluye 6 accesorios de rascado

Incluye maletín de transporte

ABS body

Continuous operation switch

Ergonomic non-slip grip

Fist protector handle

Gradual temperature control

Speed selector

Digital display

Includes 6 scraper accessories

Includes transportation case

Corpo de ABS

Interruptor de operação contínua

Agarramento ergonômico antiderrapante

Cabo com protector de punho

Controle gradual da temperatura







Selector de velocidades

Display digital

Inclui 6 acessórios de raspagem

Inclui mala de transporte



	WK402080 10 / 001-039.000
	2000 W
	300-500 LPM
	3
	50-600° C
	CE
	8 424835 007454

Lijadora triangular

Triangular sander

Lixadora triangular

Cuerpo de ABS

Interruptor de funcionamiento continuo

Sistema de extracción integrado

Agarre ergonómico antideslizante

Fijación con velcro

Incluye hoja de lijado

Incluye colector de polvo

ABS body

Continuous operation switch

Integrated extraction system

Ergonomic non-slip grip

Velcro fixing

Includes sanding sheet

Includes dust collector

Corpo de ABS

Interruptor de operação contínua

Sistema de extracção integrado







Agarramento ergonómico antiderrapante

Fixação com velcro

Inclui folha lixada

Inclui colector de pó



	WK400040 10 / 001-028.000
	200 W
	15000 RPM
	80 X 140 X 140 MM
	2 MM
	CE
	8 424835 003838

Lijadora rectangular

Rectangular sander

Lixadora rectangular

Cuerpo de ABS y base de aluminio

Interruptor de funcionamiento continuo

Sistema de extracción integrado

Agarre ergonómico antideslizante

Fijación con clip de ajuste

Incluye hoja de lijado

Incluye colector de polvo

ABS body and aluminium base

Continuous operation switch

Integrated extraction system

Ergonomic non-slip grip

Adjustment clip fixing

Includes sanding sheet

Includes dust collector

Corpo de ABS e base de alumínio

Interruptor de operação contínua

Sistema de extracção integrado







Agarramento ergonómico antiderrapante

Fixação com clipe de ajuste

Inclui folha lixada

Inclui colector de pó



	WK400050 10 / 001-030.000
	240 W
	13000 RPM
	110 X 100 MM
	2 MM
	CE
	8 424835 006013

Lijadora rectangular

Rectangular sander

Lixadora rectangular

Cuerpo de ABS y base de aluminio
Interruptor de funcionamiento continuo
Sistema de extracción integrado
Agarre ergonómico antideslizante
Mango con protector de puño
Selector de velocidades
Fijación con clip de ajuste
Incluye hoja de lijado
Incluye colector de polvo

ABS body and aluminium base
Continuous operation switch
Integrated extraction system
Ergonomic non-slip grip
Fist protector handle
Speed selector
Adjustment clip fixing
Includes sanding sheet
Includes dust collector

Corpo de ABS e base de alumínio
Interruptor de operação contínua
Sistema de extracção integrado
Agarramento ergonómico antiderrapante
Cabo com protector de punho
Selector de velocidades
Fixação com clipe de ajuste
Inclui folha lixada
Inclui colector de pó



Lijadora rectangular

Rectangular sander









Lixadora rectangular









Cuerpo de ABS y base de aluminio
Interruptor de funcionamiento continuo
Sistema de extracción integrado
Agarre ergonómico antideslizante
Mango con protector de puño
Selector de velocidades
Fijación con clip de ajuste
Incluye hoja de lijado
Incluye colector de polvo

ABS body and aluminium base
Continuous operation switch
Integrated extraction system
Ergonomic non-slip grip
Fist protector handle
Speed selector
Adjustment clip fixing
Includes sanding sheet
Includes dust collector

Corpo de ABS e base de alumínio
Interruptor de operação contínua
Sistema de extracção integrado
Agarramento ergonómico antiderrapante
Cabo com protector de punho
Selector de velocidades
Fixação com clipe de ajuste
Inclui folha lixada
Inclui colector de pó



	WK403150 8 / 001-035.000
	240 W
	6000-12000 RPM
	6
	90 X 187 MM
	2 MM
	CE
	8 424835 005818

	WK403270 8 / 001-042.000
	350 W
	6000-11000 RPM
	7
	115 X 230 MM
	2 MM
	CE / GS
	8 424835 010300

Lijadora circular

Circular sander

Lixadora circular

Cuerpo de ABS

Interruptor de funcionamiento continuo

Sistema de extracción integrado

Agarre ergonómico antideslizante

Mango con protector de puño

Selector de velocidades

Fijación con velcro

Incluye disco de lijado

Incluye colector de polvo

ABS body

Continuous operation switch

Integrated extraction system

Ergonomic non-slip grip

Fist protector handle

Speed selector

Velcro fixing

Includes sanding disc

Includes dust collector

Corpo de ABS

Interruptor de operação contínua

Sistema de extracção integrado

Agarramento ergonómico antiderrapante

Cabo com protector de punho









Selector de velocidades

Fixação com velcro

Inclui disco de lixado

Inclui colector de pó



	WK400060 8 / 001-044.000
	450 W
	6000-12000 RPM
	6
	150 MM
	2 MM
	CE
	8 424835 006020

Lijadora circular orbital

Orbital circular sander

Lixadora circular orbital

Cuerpo de ABS

Interruptor de funcionamiento continuo

Sistema de extracción integrado

Mango auxiliar orientable

Selector de velocidades

Función de giro orbital

Fijación con velcro

Incluye colector de polvo

ABS body

Continuous operation switch

Integrated extraction system

Adjustable auxiliary handle

Speed selector

Orbital spin function

Velcro fixing

Includes dust collector

Corpo de ABS

Interruptor de operação contínua

Sistema de extracção integrado

Cabo auxiliar orientável









Selector de velocidades

Função de rotação orbital

Fixação com velcro

Inclui colector pó



	WK400100 4 / 001-088.000
	710 W
	3000-6300 RPM
	6
	150 MM
	4 MM
	CE
	8 424835 006549

Lijadora circular orbital

Orbital circular sander

Lixadora circular orbital

Cuerpo de ABS

Motor sin escobillas

Sistema de extracción compatible con aspirador

Mango con protector de puño

Regulador de velocidad

Función de giro orbital

Fijación con velcro

Incluye disco microperforado de lijado

Incluye manguera de aspiración de 1.1 metros

ABS body

Brushless motor

Extraction system compatible with vacuum cleaner

Fist protector handle

Speed regulator

Orbital spin function

Velcro fixing

Includes microperforated sanding disc

Includes 1.1-meter suction hose

Corpo de ABS

Motor sem escovas

Sistema de extracção compatible com aspirador

Cabo com protector de punho

Regulador de velocidade









Função de rotação orbital

Fixação com velcro

Inclui disco microperforado de lixado

Inclui manguera de sucção de 1.1 metros



	WK400750 4 / 001-142.000
	350 W
	4000-10000 RPM
	6
	150 MM
	5 MM
	CE
	8 424835 009779

Pulidora

Polisher

Polidora

Cuerpo de ABS y aluminio

Mango auxiliar de 2 posiciones

Selector de velocidades

Fijación con velcro

Incluye caperuza de pulido

ABS and aluminium body

2-position auxiliary handle

Speed selector

Velcro fixing

Includes polish bonnet

Corpo de ABS e alumínio









Cabo auxiliar de 2 posições

Selector de velocidades

Fixação com velcro

Inclui carapuça de polido



	WK400110 4 / 001-045.000
	1010 W
	1000-4500 RPM
	7
	180 MM
	2 MM
	M-14
	CE
	8 424835 001834

Pulidora

Polisher









Polidora

Cuerpo de ABS y aluminio
Agarre ergonómico antideslizante
Mango auxiliar orientable
Selector de velocidades
Fijación con velcro
Incluye caperuza de pulido

ABS and aluminium body
Ergonomic non-slip grip
Adjustable auxiliary handle
Speed selector
Velcro fixing
Includes polish bonnet

Corpo de ABS e alumínio
Agarramento ergonômico antiderrapante
Cabo auxiliar orientável
Selector de velocidades
Fixação com velcro
Inclui carapuça de polido



	WK402120 4 / 001-062.000
	1400 W
	1000-3000 RPM
	7
	180 MM
	2 MM
	M-14
	CE
	8 424835 008307

Amoladora

Grinder

Rebarbadora

Cuerpo de ABS y aluminio

Interruptor de funcionamiento continuo

Agarre ergonómico

Mango auxiliar de 2 posiciones

Protector de disco orientable

ABS and aluminium body

Continuous operation switch

Ergonomic grip

2-position auxiliary handle

Adjustable disc protector

Corpo de ABS e alumínio

Interruptor de operação contínua

Agarramento ergonômico

Cabo auxiliar de 2 posições

Protetor de disco orientável



	WK400900 6 / 001-032.000	WK400910 6 / 001-034.000
	900 W	1100 W
	12000 RPM	12000 RPM
	115/125 X 22 MM	115/125 X 22 MM
	M-14	M-14
	CE	CE
	8 424835 007904	8 424835 007911

Amoladora

Grinder

Rebarbadora

Cuerpo de ABS y aluminio

Agarre ergonómico antideslizante

Mango auxiliar de 3 posiciones

Cabezal orientable - Arranque suave

Protector de disco orientable

ABS and aluminium body

Ergonomic non-slip grip

3-position auxiliary handle

Adjustable head - Soft start

Adjustable disc protector

Corpo de ABS e alumínio

Agarramento ergonômico antiderrapante

Cabo auxiliar de 3 posições

Cabeça ajustável - Arranque suave

Protetor de disco orientável



	WK401050 2 / 001-066.000
	2350 W
	6600 RPM
	230 X 22 MM
	M-14
	CE
	8 424835 009946

Amoladora inalámbrica

Cordless grinder

Rebarbadora sem fios

Cuerpo de ABS y aluminio

Agarre ergonómico antideslizante

Mango auxiliar de 2 posiciones

Protector de disco orientable

Indicador LED de carga de batería

Incluye 2 baterías

Incluye bolsa de transporte

ABS and aluminium body

Ergonomic non-slip grip

2-position auxiliary handle

Adjustable disc protector

Battery charge LED indicator

Includes 2 batteries

Includes transportation bag

Corpo de ABS e alumínio

Agarramento ergonômico antiderrapante

Cabo auxiliar de 2 posições

Protetor de disco orientável

Indicador LED de carga da bateria

Inclui 2 baterias

Inclui bolsa de transporte



	WK401620 5 / 001-109.000
	20V = 4.0 AH LI-ION
	2.5 H
	8500 RPM
	115/125 X 22 MM
	M-14
	CE
	8 424835 010096

Sierra calar

Jig saw

Serra recortes

Cuerpo de ABS

Interruptor con botón de funcionamiento continuo

Sistema de extracción compatible con aspirador

Agarre ergonómico antideslizante

Mango con protector de puño

Selector de velocidades

Función láser

Base graduable

Portasierras automático

Incluye 2 hojas de sierra

Incluye guía de corte

ABS body

Switch with continuous operation button

Extraction system compatible with vacuum cleaner

Ergonomic non-slip grip

Fist protector handle

Speed selector

Laser function

Adjustable base

Automatic saw chuck

Includes 2 saw blades

Includes cutting guide

Corpo de ABS

Interruptor com botão de operação contínua

Sistema de extracção compatible com aspirador

Agarramento ergonómico antiderrapante

Cabo com protector de punho

Selector de velocidades

Função laser











Base graduável

Portasierras automático

Inclui 2 lâminas de serra

Inclui guia de corte



	WK400950 8 / 001-046.000
	800 W
	0-3000 RPM
	6
	22 MM
	4
	≤ 100 MM
	≤ 10 MM
	0-45°
	CE
	8 424835 007959

Sierra sable inalámbrica

Cordless reciprocating saw

Serra sabre sem fios

Cuerpo de ABS - Agarre ergonómico antideslizante

Indicador LED de carga de batería

Base extensible - Portasierras automático

Incluye 2 baterías y 2 hojas de sierra

ABS body - Ergonomic non-slip grip

Battery charge LED indicator

Extendable base - Automatic saw chuck

Includes 2 batteries and 2 saw blades

Corpo de ABS - Agarramento ergonómico antiderrapante

Indicador LED de carga da bateria

Base extensível - Portaserras automático

Inclui 2 baterias e 2 lâminas de serra



Sierra sable

Reciprocating saw

Serra sabre

Cuerpo de ABS - Agarre ergonómico antideslizante

Interruptor con botón de funcionamiento continuo

Mango con protector de puño

Base extensible - Portasierras automático

Cabezal graduable - Incluye 2 hojas de sierra

ABS body - Ergonomic non-slip grip

Switch with continuous operation button

Fist protector handle

Extendable base - Automatic saw chuck

Adjustable head - Includes 2 saw blades

Corpo de ABS - Agarramento ergonómico antiderrapante

Interruptor com botão de operação contínua

Cabo com protector de punho

Base extensível - Portaserras automático

Cabeçal ajustável - Inclui 2 lâminas de serra



	WK401030 6 / 001-058.000
	12V = 2.0 AH LI-ION
	1.5 H
	0-2200 RPM
	13 MM
	≤ 50 MM
	≤ 5 MM
	10°
	CE
	8 424835 009731

	WK403160 6 / 001-054.000
	710 W
	0-2600 RPM
	20 MM
	≤ 115 MM
	≤ 10 MM
	180°
	CE
	8 424835 006709

Hoja lija

Sanding sheet

Folha lixa



Cuerpo de papel, resina y óxido de aluminio
Microperforado
Grano semiabierto
Fijación con velcro

Paper, resin and aluminium-oxide body
 Microperforated
 Semi-open grain
 Velcro fixing

Corpo de papel, resina e óxido de alumínio
 Microperforado
 Grano semiabierto
 Fixação com velcro

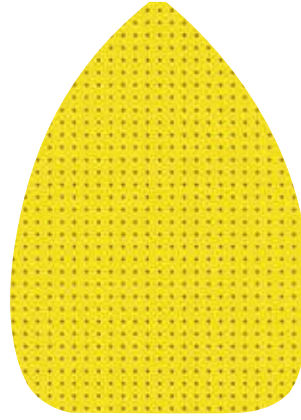

	WK302230 100 / 005-002.200	WK302240 100 / 005-002.200	WK302250 100 / 005-002.200
	80 X 140 X 140 MM	80 X 140 X 140 MM	80 X 140 X 140 MM
	60	80	120
PCS	10	10	10
	8 424835 010409	8 424835 010416	8 424835 010423

Disco lija

Sanding disc

Disco lixa

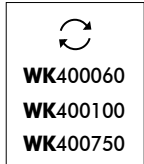

Cuerpo de papel, resina y óxido de aluminio
Microperforado
Grano semiabierto
Fijación con velcro

Paper, resin and aluminium-oxide body
 Microperforated
 Semi-open grain
 Velcro fixing

Corpo de papel, resina e óxido de alumínio
 Microperforado
 Grano semiabierto
 Fixação com velcro

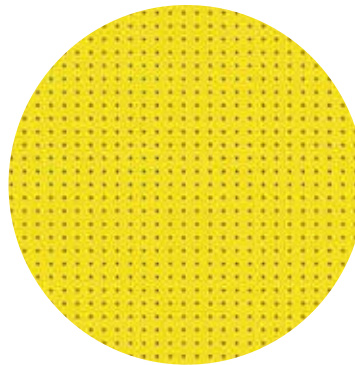

	WK300440 50 / 005-003.600	WK300450 50 / 005-003.600	WK300460 50 / 005-003.600	WK300470 50 / 005-003.600	WK300480 50 / 005-003.600
	150 MM	150 MM	150 MM	150 MM	150 MM
	60	80	100	120	150
PCS	10	10	10	10	10
	8 424835 010430	8 424835 010447	8 424835 010454	8 424835 010461	8 424835 010478

Disco lija

Sanding disc

Disco lixa

Cuerpo de papel, resina y óxido de aluminio

Microperforado

Grano semiabierto

Fijación con velcro

Paper, resin and aluminium-oxide body

Microperforated

Semi-open grain

Velcro fixing

Corpo de papel, resina e óxido de alumínio

Microperforado

Grano semiaberto

Fixação com velcro



WK400030

WK400080

WK403070

WK403260

WK403250

WK601760

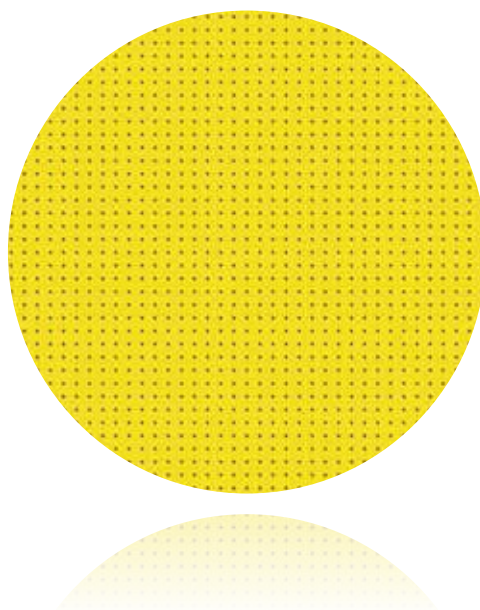

	WK300770 50 / 005-007.400	WK300780 50 / 005-007.400	WK300790 50 / 005-007.400
	225 MM	225 MM	225 MM
	60	80	100
PCS	10	10	10
	8 424835 010485	8 424835 010492	8 424835 010508

	WK300800 50 / 005-007.400	WK300810 50 / 005-007.400	WK300820 50 / 005-007.400	WK300830 50 / 005-007.400
	225 MM	225 MM	225 MM	225 MM
	120	150	180	220
PCS	10	10	10	10
	8 424835 010515	8 424835 010522	8 424835 010539	8 424835 010546

Hoja lija

Sanding sheet

Folha lixa



Cuerpo de papel, resina y óxido de aluminio
Microperforado
Grano semiabierto
Fijación con clip de ajuste

Paper, resin and aluminium-oxyde body
 Microperforated
 Semi-open grain
 Adjustment clip fixing

Corpo de papel, resina e óxido de alumínio
 Microperforado
 Grano semiabierto
 Fixação com clipe de ajuste



	WK300330 50 / 005-002.400	WK300340 50 / 005-002.400	WK300350 50 / 005-002.400
	110 X 140 MM	110 X 140 MM	110 X 140 MM
	60	80	120
PCS	10	10	10
	8 424835 010317	8 424835 010324	8 424835 010331

Hoja lija

Sanding sheet

Folha lixa



Cuerpo de papel, resina y óxido de aluminio
Microperforado
Grano semiabierto
Fijación con clip de ajuste

Paper, resin and aluminium-oxyde body
 Microperforated
 Semi-open grain
 Adjustment clip fixing

Corpo de papel, resina e óxido de alumínio
 Microperforado
 Grano semiabierto
 Fixação com clipe de ajuste



	WK301310 50 / 005-003.000	WK301320 50 / 005-003.000	WK301330 50 / 005-003.000
	90 X 230 MM	90 X 230 MM	90 X 230 MM
	60	80	120
PCS	10	10	10
	8 424835 010348	8 424835 010355	8 424835 010362

Hoja lija

Sanding sheet

Folha lixa

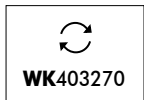

Cuerpo de papel, resina y óxido de aluminio

Microperforado

Grano semiabierto

Fijación con clip de ajuste

Paper, resin and aluminium-oxide body

Microperforated

Semi-open grain

Adjustment clip fixing

Corpo de papel, resina e óxido de alumínio

Microperforado

Grano semiabierto

Fixação com clipe de ajuste



	WK300630 50 / 05-005.400	WK300640 50 / 05-005.400	WK300650 50 / 05-005.400
	115 X 280 MM	115 X 280 MM	115 X 280 MM
	60	80	120
PCS	10	10	10
	8 424835 010379	8 424835 010386	8 424835 010393

Caperuza pulido

Polish bonnet

Carapuça polido

Cuerpo de poliéster y algodón
Fijación con velcro

Polyester and cotton body
Velcro fixing

Corpo de poliéster e algodão
Fixação com velcro

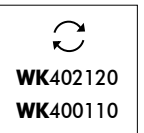

	WK302690 6 / 006-004.600
	180 MM
	8 424835 001230

Disco pulido esponja

Sponge polish disc

Disco polido esponja

Cuerpo de esponja de poliuretano
Poros gruesos
Fijación con velcro

Poliurethane sponge body
Coarse pore
Velcro fixing

Corpo de esponja de poliuretano
Poros grosso
Fixação com velcro

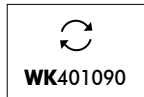

	WK300250 40 / 001-006.200
	390 MM
	45 MM
	8 424835 010690

Hoja sierra corte madera

Wood cutting sawblade

Lâmina serra corte madeira



Cuerpo de acero de alto carbono

Fijación tipo T

High carbon steel body

T type fixing

Corpo de aço de alto carbono

Fixação tipo T



Ø	WK300180
⊥	6 / 006-003.200
↕	115 MM
↔	8 MM
PCS	5
	8 424835 008192

Hoja sierra corte metal

Metal cutting sawblade

Lâmina serra corte metal



Cuerpo de acero de alto carbono

Fijación tipo T

High carbon steel body

T type fixing

Corpo de aço de alto carbono

Fixação tipo T



Ø	WK300170
⊥	6 / 006-004.200
↕	80 MM
↔	8 MM
PCS	5
	8 424835 008185

Hoja sierra corte madera

Wood cutting sawblade

Lâmina serra corte madeira

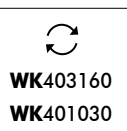

Cuerpo de acero de alto carbono

Fijación tipo universal

High carbon steel body

Universal type fixing

Corpo de aço de alto carbono

Fixação tipo universal



Ø	WK300190
⊥	6 / 006-003.600
↕	150 MM
↔	10 MM
PCS	5
	8 424835 003333

Hoja sierra corte metal

Metal cutting sawblade

Lâmina serra corte metal

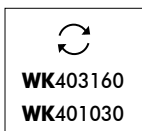

Cuerpo de acero de alto carbono

Fijación tipo universal

High carbon steel body

Universal type fixing

Corpo de aço de alto carbono

Fixação tipo universal



Ø	WK302170
⊥	6 / 006-005.200
↕	105 MM
↔	14 MM
PCS	5
	8 424835 004507

Atornillador inalámbrico

Cordless driver

Aparafusador sem fios

Cuerpo de ABS

Agarre ergonómico antideslizante

Función de rotación reversible

Indicador LED de carga de batería

Luz LED integrada

Portapuntas imantado

Función de taladrado (sin percusión)

Incluye 23 brocas/puntas

Incluye maletín de transporte

ABS body

Ergonomic non-slip grip

Reversible rotation function

Battery charge LED indicator

Integrated LED light

Magnetic bit holder

Drill function (without impact)

Includes 23 drill-bits/bits

Includes transportation case

Corpo de ABS

Agarramento ergonómico antiderrapante

Função de rotação reversível

Indicador LED de carga da bateria

Luz LED integrada

Porta-pontas magnético

Função de perfurado (sem percussão)

Inclui 23 brocas/pontas

Inclui mala de transporte



	WK400270 10 / 001-019.000
	3.6V ⇒ 2.0 AH LI-ION
	3-5 H
	180 RPM
	HEX-6
	≤ 20 MM
	≤ 8 MM
	≤ 8 MM
	CE
	8 424835 009236

Atornillador percutor inalámbrico

Cordless impact driver

Aparafusador percussor sem fios

Cuerpo de ABS

Agarre ergonómico antideslizante

Función de rotación reversible

Indicador LED de carga de batería

Luz LED integrada

Cabezal graduable

Función de taladrado (con percusión)

Incluye 2 baterías

Incluye 2 puntas

ABS body

Ergonomic non-slip grip

Reversible rotation function

Battery charge LED indicator

Integrated LED light

Adjustable head

Drill function (with impact)

Includes 2 batteries

Includes 2 bits

Corpo de ABS

Agarramento ergonómico antiderrapante

Função de rotação reversível

Indicador LED de carga da bateria

Luz LED integrada

Cabeçal ajustável

Função de perfurado (com percussão)

Inclui 2 baterias

Inclui 2 pontas



	WK401040 10 / 001-032.000
	7.2V ⇒ 2.0 AH LI-ION
	1.5 H
	0-2300 RPM
	0-3000 IPM
	HEX-6
	≤ 20 MM
	≤ 8 MM
	≤ 5 MM
	≤ 8 MM
	CE
	8 424835 009748

Atornillador yeso Drywall screwdriver

Aparafusador gesso

Cuerpo de ABS y aluminio

Interruptor con botón de funcionamiento continuo

Agarre ergonómico antideslizante

Función de rotación reversible

Regulador de profundidad

Clip de sujeción para el cinturón

Portapuntas imantado

Incluye correa de sujeción

ABS and aluminium body

Switch with continuous operation button

Ergonomic non-slip grip

Reversible rotation function

Depth regulator

Fastening belt clip

Magnetic bit holder

Includes clamping strap

Corpo de ABS e alumínio

Interruptor com botão de operação contínua

Agarramento ergonômico antiderrapante

Função de rotação reversível









Regulador de profundidade

Clipe de sujeição para o cinto

Porta-pontas magnético

Inclui correia de sujeição



	WK40090 6 / 001-046.000
	550 W
	0-4500 RPM
	HEX-6
	6 MM
	0-20 MM
	CE
	8 424835 001681

Taladro atornillador inalámbrico

Cordless driver drill

Berbequim aparafusador sem fios

Cuerpo de ABS

Agarre ergonómico antideslizante

Selector de 2 rangos de revoluciones

Función de rotación reversible

Indicador LED de carga de batería

Luz LED integrada

Portabrocas automático

Función de taladrado (sin percusión)

Clip de sujeción para el cinturón

Incluye 2 baterías

Incluye maletín de transporte

ABS body

Ergonomic non-slip grip

2-speed range selector

Reversible rotation function

Battery charge LED indicator

Integrated LED light

Keyless chuck

Drill function (without impact)

Fastening belt clip

Includes 2 batteries

Includes transportation case

Corpo de ABS

Agarramento ergonómico antiderrapante

Selector de 2 níveis de rotações

Função de rotação reversível

Indicador LED de carga da bateria

Luz LED integrada

Bucha automática











Função de perfurado (sem percussão)

Clipe de sujeição para o cinto

Inclui 2 baterias

Inclui mala de transporte



	WK400280 5 / 001-048.000
	12V = 2.0 AH LI-ION
	1.5 H
	0-350 / 0-1100 RPM
	17+1
	≤ 10 MM
	≤ 20 MM
	≤ 8 MM
	6 MM
	CE
	8 424835 009243

Taladro atornillador-percutor inalámbrico

Cordless impact-driver drill

Berbequim aparafusador-percussor sem fios

Cuerpo de ABS

Agarre ergonómico antideslizante

Selector de 2 rangos de revoluciones

Función de rotación reversible

Indicador LED de carga de batería

Luz LED integrada

Portabrocas automático metálico

Función de taladrado (con y sin percusión)

Clip de sujeción para el cinturón

Incluye 2 baterías

Incluye maletín de transporte

ABS body

Ergonomic non-slip grip

2-speed range selector

Reversible rotation function

Battery charge LED indicator

Integrated LED light

Metallic keyless chuck

Drill function (with and without impact)

Fastening belt clip

Includes 2 batteries

Includes transportation case

Corpo de ABS

Agarramento ergonômico antiderrapante

Selector de 2 níveis de rotações

Função de rotação reversível

Indicador LED de carga da bateria

Luz LED integrada

Bucha automática metálica

Função de perfuração (com e sem percussão)

Clipe de sujeição para o cinto

Inclui 2 baterias

Inclui mala de transporte



	WK400290 4 / 001-088.000
	20V = 2.0 AH LI-ION
	1.5 H
	0-400 / 0-1400 RPM
	0-4550 / 0-18200 IPM
	18+2
	≤ 13 MM
	≤ 32 MM
	≤ 13 MM
	≤ 12 MM
	6 MM
	CE
	8 424835 009250

Taladro martillo percutor

Impact hammer drill

Berbequim martelo percussor

Cuerpo de ABS y aluminio

Agarre ergonómico antideslizante

Mango auxiliar orientable

Regulador de velocidad

Selector de 2 rangos de revoluciones

Función de rotación reversible

Portabrocas automático

Interruptor con botón de funcionamiento continuo

Función de taladrado (con y sin percusión)

ABS and aluminium body

Ergonomic non-slip grip

Adjustable auxiliary handle

Speed regulator

2-speed range selector

Reversible rotation function

Keyless chuck

Switch with continuous operation button

Drill function (with and without impact)

Corpo de ABS e alumínio

Agarramento ergonômico antiderrapante

Cabo auxiliar orientável

Regulador de velocidade

Selector de 2 níveis de rotações











Função de rotação reversível

Bucha automática

Interruptor com botão de operação contínua

Função de perfurado (com e sem percussão)



	WK403170 5 / 001-052.000
	1050 W
	0-1100 / 0-3000 RPM
	0-52300 IPM
	2-13 MM
	≤ 40 MM
	≤ 16 MM
	≤ 20 MM
	CE
	8 424835 006617

Taladro martillo demoledor

Demolition hammer drill

Berbequim martelo demolidor

Cuerpo de ABS y aluminio

Interruptor con botón de funcionamiento continuo

Agarre ergonómico antideslizante - Mango auxiliar orientable

Mango con protector de puño

Regulador de velocidad - Función de rotación reversible

Función de taladrado (con y sin percusión)

Función de cincelado (con y sin giro)

Incluye 2 cinceles y 3 brocas

Incluye maletín de transporte

ABS and aluminium body

Switch with continuous operation button

Ergonomic non-slip grip - Adjustable auxiliary handle

Fist protector handle

Speed regulator - Reversible rotation function

Drill function (with and without impact)

Chisel function (with and without spin)

Includes 2 chisels and 3 drill-bits

Includes transportation case

Corpo de ABS e alumínio

Interruptor com botão de operação contínua

Agarramento ergonômico antiderrapante - Cabo auxiliar orientável

Cabo com protector de punho

Regulador de velocidade - Função de rotação reversível











Função de perfurado (com e sem percussão)

Função de cincelado (com e sem virada)

Inclui 2 cinzeis e 3 brocas

Inclui mala de transporte



	WK402240 4 / 001-088.000
	1050 W
	0-1100 RPM
	0-4900 IPM
	3 J
	SDS PLUS
	≤ 40 MM
	≤ 16 MM
	≤ 26 MM
	CE
	8 424835 007119

Taladro martillo demoledor inalámbrico

Cordless demolition hammer drill

Berbequim martelo demolidor sem fios

Cuerpo de ABS y aluminio

Motor sin escobillas

Agarre ergonómico antideslizante

Mango auxiliar orientable

Mango con protector de puño

Función de rotación reversible

Función de taladrado (con y sin percusión)

Función de cincelado (con y sin giro)

Luz LED integrada

Incluye 2 cinceles y 3 brocas

Incluye 2 baterías

Incluye maletín de transporte

ABS and aluminium body

Brushless motor

Ergonomic non-slip grip

Adjustable auxiliary handle

Fist protector handle

Reversible rotation function

Drill function (with and without impact)

Chisel function (with and without spin)

Integrated LED light

Includes 2 chisels and 3 drill-bits

Includes 2 batteries

Includes transportation case

Corpo de ABS e alumínio

Motor sem escovas

Agarramento ergonómico antiderrapante

Cabo auxiliar orientável

Cabo com protector de punho

Função de rotação reversível

Função de perfuração (com e sem percussão)

Função de cincelado (com e sem virada)













Luz LED integrada

Inclui 2 cinzeis e 3 brocas

Inclui 2 baterias

Inclui mala de transporte



	WK401630 4 / 001-158.000
	20V = 4.0 AH LI-ION
	2 H
	0-1150 RPM
	0-4700 IPM
	3 J
	SDS PLUS
	≤ 34 MM
	≤ 14 MM
	≤ 18 MM
	CE
	8424835 010287

Taladro martillo demoledor

Demolition hammer drill

Berbequim martelo demolidor

Cuerpo de ABS y aluminio

Agarre ergonómico antideslizante

Mango auxiliar orientable

Mango con protector de puño

Selector de velocidades

Función de taladrado (con percusión)

Función de cincelado (con y sin giro)

Sistema antivibración

Incluye broca y cincel

Incluye maletín de transporte

ABS and aluminium body

Ergonomic non-slip grip

Adjustable auxiliary handle

Fist protector handle

Speed selector

Drill function (with impact)

Chisel function (with and without spin)

Anti-vibration system

Includes drill-bit and chisel

Includes transportation case

Corpo de ABS e alumínio

Agarramento ergonômico antiderrapante

Cabo auxiliar orientável

Cabo com protector de punho

Selector de velocidades

Função de perfurado (com percussão)

Função de cincelado (com e sem virada)

Sistema antivibração

Inclui broca e cincel

Inclui mala de transporte



	WK401020 2 / 001-206.000
	1100 W
	300-760 RPM
	1950-4850 IPM
	6
	7 J
	SDS MAX
	≤ 35 MM
	CE
	8 424835 009267

Martillo demoledor

Demolition hammer

Martelo demolidor

Cuerpo de ABS y aluminio

Agarre ergonómico antideslizante

Mango auxiliar orientable

Mango con protector de puño

Interruptor de funcionamiento continuo

Selector de velocidades

Función de cincelado (con y sin giro)

Sistema antivibración

Incluye cincel

Incluye maletín de transporte

ABS and aluminium body

Ergonomic non-slip grip

Adjustable auxiliary handle

Fist protector handle

Continuous operation switch

Speed selector

Chisel function (with and without spin)

Anti-vibration system

Includes chisel

Includes transportation case

Corpo de ABS e alumínio

Agarramento ergonômico antiderrapante

Cabo auxiliar orientável

Cabo com protector de punho

Interruptor de operação contínua

Selector de velocidades

Função de cincelado (com e sem virada)

Sistema antivibração

Inclui cincel

Inclui mala de transporte



	WK400610 2 / 001-186.000
	1200 W
	2700-3700 IPM
	6
	14 J
	SDS MAX
	CE
	8 424835 007058

Martillo demoledor

Demolition hammer

Martelo demolidor

Cuerpo de ABS y aluminio

Agarre ergonómico antideslizante

Mango auxiliar orientable

Mango con protector de puño

Interruptor de funcionamiento continuo

Selector de velocidades

Función de cincelado (con y sin giro)

Sistema antivibración

Incluye cincel

Incluye maletín de transporte

ABS and aluminium body

Ergonomic non-slip grip

Adjustable auxiliary handle

Fist protector handle

Continuous operation switch

Speed selector

Chisel function (with and without spin)

Anti-vibration system

Includes chisel

Includes transportation case

Corpo de ABS e alumínio

Agarramento ergonômico antiderrapante

Cabo auxiliar orientável

Cabo com protector de punho

Interruptor de operação contínua

Selector de velocidades









Função de cincelado (com e sem virada)

Sistema antivibração

Inclui cinzel

Inclui mala de transporte



	WK400240 1 / 001-258.000
	1500 W
	1000-1900 IPM
	6
	25 J
	SDS MAX
	CE
	8 424835 007713

Martillo demoledor

Demolition hammer

Martelo demolidor

Cuerpo de ABS y aluminio

Interruptor de funcionamiento continuo

Agarre ergonómico antideslizante

Mango auxiliar orientable

Mango con protector de puño

Sistema antivibración

Función de cincelado (sin giro)

Incluye cincel y puntero

Incluye maletín de transporte

ABS and aluminium body

Continuous operation switch

Ergonomic non-slip grip

Adjustable auxiliary handle

Fist protector handle

Anti-vibration system

Chisel function (without spin)

Includes chisel and pointer

Includes transportation case

Corpo de ABS e alumínio

Interruptor de operação contínua

Agarramento ergonômico antiderrapante

Cabo auxiliar orientável

Cabo com protector de punho

Sistema antivibração

Função de cincelado (sem virada)

Inclui cincel e ponteiro

Inclui mala de transporte



Martillo demoledor

Demolition hammer

Martelo demolidor

Cuerpo de ABS y aluminio

Agarre ergonómico antideslizante

Función de cincelado (sin giro)

Sistema antivibración

Incluye cincel y puntero

Incluye maletín de transporte

ABS and aluminium body

Ergonomic non-slip grip

Chisel function (without spin)

Anti-vibration system

Includes chisel and pointer

Includes transportation case

Corpo de ABS e alumínio

Agarramento ergonômico antiderrapante







Função de cincelado (sem virada)







Sistema antivibração

Inclui cincel e ponteiro

Inclui mala de transporte



	WK403180 1 / 001-350.000
	1600 W
	1450 IPM
	60 J
	HEX-30
	CE
	8 424835 009656

	WK403200 1 / 001-630.000
	2200 W
	950 IPM
	80 J
	HEX-28
	CE
	8 424835 009670

Carro martillo demoledor

Demolition hammer trolley

Carro martelo demolidor

Cuerpo de acero carbono

Ruedas de PU de 200 mm

Incluye 4 portacinceles/punteros

Carbon steel body

PU wheels of 200 mm

Includes 4 chisel/pointer holders

Corpo de aço carbono

Rodas de PU de 200 mm

Inlcui 4 porta-cinzeis/ponteiros



WK403200

	WK403190 1 / 001-075.000
	135 KG
	1065 MM
	485 MM
	8 424835 009663

Expositor martillos demoledores

Demolition hammer display stand

Expositor martelos demolidores

Cuerpo de acero carbono

Capacidad de 9 martillos demoledores

Carbon steel body

Capacity of 9 demolition hammers

Corpo de aço carbono

Capacidade de 9 martelos demolidores

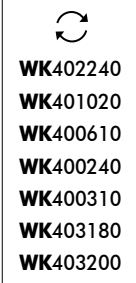

WK402240

WK401020

WK400610

WK400240

WK400310

WK403180

WK403200

	WK400230 1 / 001-072.000
	1500 MM
	640 MM
	8 424835 009519

Soporte polipasto

Hoist frame

Suporte garibalde

Cuerpo de acero inoxidable

Compatible con polipastos eléctricos universales

Compatible con andamios de estructura redonda universales

Stainless-steel body

Compatible with universal electric hoists

Compatible with universal round frame scaffolds

Corpo de aço inoxidável

Compatível com garibaldes elétricos universais

Compatível com andaimes de armação redonda universais



WK400160







WK400170

WK400220

WK400540

WK400550



	WK400510 4 / 001-046.000
	600 KG
	750 MM
	48 MM
	180°
	TÜV GS
	8 424835 000714

Polipasto cable

Cable hoist

Garibalde cabo

Cuerpo de aluminio y acero carbono
Interruptor de seguridad electromagnético
Gancho de seguridad con contrapeso
Sistema con polea de reenvío
Incluye abrazaderas de soporte

Aluminium and carbon steel body
 Electromagnetic safety switch
 Counterweight safety hook
 Forward-pulley system
 Includes support brackets

Corpo de alumínio e aço carbono
 Interruptor de segurança electromagnético
 Gancho de segurança com contrapeso
 Sistema com roldana de reenvio
 Inclui braçadeiras de suporte



	WK400160 2 / 001-100.000	WK400170 2 / 001-142.000	WK400220 2 / 001-178.000	WK400540 2 / 001-244.000	WK400550 1 / 001-334.000
	100 KG / 200 KG	200 KG / 400 KG	300 KG / 600 KG	400 KG / 800 KG	500 KG / 1000 KG
	450 W	750 W	1050 W	1350 W	1600 W
	2500 RPM	2500 RPM	2500 RPM	2500 RPM	2500 RPM
	8 MPM / 4 MPM	8 MPM / 4 MPM	10 MPM / 5 MPM	10 MPM / 5 MPM	8 MPM / 4 MPM
	18 M / 9 M	22 M / 11 M	22 M / 11 M	22 M / 11 M	22 M / 11 M
	18 M	22 M	22 M	22 M	22 M
	3 MM	3.8 MM	4.5 MM	5 MM	5.6 MM
	CE	CE	CE	CE	CE
	8 424835 505042	8 424835 510053	8 424835 510046	8 424835 000738	8 424835 000745

Proyector LED luz trabajo

Work light LED projector

Projektor LED luz trabalho

Cuerpo de aluminio y acero carbono

Agarre ergonómico antideslizante

Compatible para uso interior y exterior

Base graduable

Aluminium and carbon steel body

Ergonomic non-slip grip

Compatible for indoor and outdoor use

Adjustable base

Corpo de alumínio e aço carbono

Agarramento ergonómico antiderrapante

Compatível para uso interior e exterior

Base graduável



	WK402150 4 / 001-039.000	WK402160 4 / 001-052.000	WK403210 2 / 001-088.000	WK403220 2 / 001-099.000
	30 W	50 W	100 W	150 W
	SMD / 72 X EPISTAR	SMD / 120 X EPISTAR	SMD / 240 X EPISTAR	SMD / 360 X EPISTAR
	2700 LM	4500 LM	9000 LM	11000 LM
	6500 K	6500 K	6500 K	6500 K
	130°	130°	130°	130°
	20 M	30 M	40 M	50 M
	200 X 170 X 60 MM	240 X 200 X 60 MM	280 X 250 X 80 MM	360 X 290 X 80 MM
	10000 H	10000 H	10000 H	10000 H
	CE	CE	CE	CE
	8 424835 008000	8 424835 008017	8 424835 009038	8 424835 009045

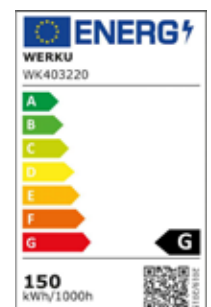
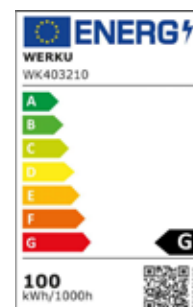
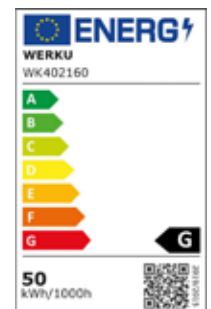
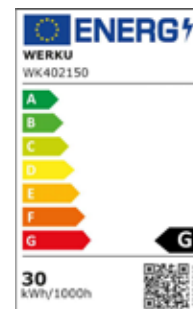

Enrollacables alargador

Cable roller extension

Enrola cabos prolongador

Cuerpo de aluminio y acero carbono

Agarre ergonómico antideslizante

Compatible para uso interior

Protección de sobrecalentamiento

Sistema de protección infantil

Manivela de recogida

Aluminium and carbon steel body

Ergonomic non-slip grip

Compatible for indoor use

Overheat protection

Child protection system

Roller handle

Corpo de alumínio e aço carbono

Agarramento ergonómico antiderrapante

Compatível para uso interior

Proteção de sobreaquecimento

Sistema de proteção infantil

Manivela de recolhida



○ ┃	WK402420 1 / 001-032.000	WK402430 1 / 001-056.000
↕	25 M	50 M
☺	4	4
⊙⚡	H05VV-F 3G1.5MM ²	H05VV-F 3G1.5MM ²
⊙ MAX	≤ 3500 W	≤ 3500 W
☑	CE	CE
	8 424835 008161	8 424835 008178

Hidrolavadora alta presión

High pressure washer

Lavadora alta pressão

Cuerpo de ABS y aluminio

Agarre ergonómico antideslizante

Mango con protector de puño

Motor sin escobillas

Incluye manguera de alta presión de 5 metros

Incluye pistola con lanza

ABS and aluminium body

Ergonomic non-slip grip

Fist protector handle

Brushless motor

Includes 5-meter high pressure hose

Includes gun with lance

Corpo de ABS e alumínio

Agarramento ergonómico antiderrapante

Cabo com protector de punho

Motor sem escovas

Inclui mangueria de alta pressão de 5 metros

Inclui pistola com lança



	WK400890 1 / 001-099.000
	1300 W
	2800 RPM
	70 BAR
	100 BAR
	6 LPM
	6.5 LPM
	≤ 50° C
	CE
	8 424835 009564

Hidrolavadora alta presión

High pressure washer

Lavadora alta pressão

Cuerpo de ABS, aluminio y acero carbono

Ruedas de ABS de 170 mm

Agarre ergonómico antideslizante

Mango con protector de puño

Función de absorción directa de químicos

Motor sin escobillas

Incluye manguera de alta presión de 8 metros

Incluye pistola con lanza

Incluye boquillas de 0, 15 y 40 grados

ABS, aluminium and carbon steel body

ABS wheels of 170 mm

Ergonomic non-slip grip

Fist protector handle

Direct chemical absorption function

Brushless motor

Includes 8-meter high pressure hose

Includes gun with lance

Includes 0, 15- and 40-degree nozzles

Corpo de ABS, alumínio e aço carbono

Rodas de ABS de 170 mm

Agarramento ergonômico antiderrapante

Cabo com protector de punho

Função de absorção direta de produtos químicos

Motor sem escovas

Inclui mangueira de alta pressão de 8 metros

Inclui pistola com lança

Inclui boquilhas de 0, 15 e 40 graus



Hidrolavadora alta presión

High pressure washer

Lavadora alta pressão

Cuerpo de ABS, aluminio y acero carbono

Ruedas de caucho de 200 mm

Agarre ergonómico antideslizante

Mango con protector de puño

Función de absorción directa de químicos

Motor sin escobillas

Incluye manguera de alta presión de 8 metros

Incluye pistola con lanza

Incluye boquillas de 0, 15, 40 y 60 grados

ABS, aluminium and carbon steel body

Rubber wheels of 200 mm

Ergonomic non-slip grip

Fist protector handle

Direct chemical absorption function

Brushless motor

Includes 8-meter high pressure hose

Includes gun with lance

Includes 0, 15, 40- and 60-degree nozzles

Corpo de ABS, alumínio e aço carbono

Rodas de borracha de 200 mm

Agarramento ergonômico antiderrapante

Cabo com protector de punho

Função de absorção direta de produtos químicos

Motor sem escovas

Inclui mangueira de alta pressão de 8 metros

Inclui pistola com lança

Inclui boquilhas de 0, 15, 40 e 60 graus



	WK400710 1 / 001-420.000
	2200 W
	2900 RPM
	80 BAR
	120 BAR
	10.5 LPM
	12 LPM
	≤ 50° C
	CE
	8 424835 009540

	WK400720 1 / 001-680.000
	3700 W
	2900 RPM
	180 BAR
	200 BAR
	7 LPM
	9.5 LPM
	≤ 50° C
	CE
	8 424835 009557

Herramientas neumáticas y airless

Pneumatic and airless tools

Ferramentas pneumáticas e airless



Pistola pintar gravedad retoques HVLP-I HVLP-I retouch gravity paint spray gun

Pistola pintar gravidade retoques HVLP-I

Cuerpo de aluminio
Acabado cromado y pulido
Agarre ergonómico
Regulador de abanico
Regulador de fluido
Regulador de presión
Incluye kit de limpieza

Aluminium body
Polished chrome finish
Ergonomic grip
Pattern regulator
Fluid regulator
Pressure regulator
Includes cleaning kit











Corpo de alumínio
Acabamento cromado e polido
Agarramento ergonómico
Regulador de leque
Regulador de fluido
Regulador de pressão
Inclui kit de limpeza



HVLP-I (alto volumen a baja presión) reduce el consumo del producto a pulverizar un 30%, acorta el tiempo de trabajo un 20%, disminuye el consumo de aire un 15% y genera una buena calidad de pulverización y acabado.

HVLP-I (high volume at low pressure) reduces the consumption of the product to be sprayed by 30%, shortens the working time by 20%, reduces air consumption by 15% and generates a good quality of spray and finish.

HVLP-I (alto volumen a baixa pressão) reduz o consumo do produto a ser pulverizado em 30%, reduz o tempo de trabalho em 20%, reduz o consumo de ar em 15% e gera uma boa qualidade de pulverização e acabamento.

	WK500730 20 / 001-015.000
	≥ 1.5 HP
	2.5 - 3.5 BAR
	8 BAR
	BSP 1/4"
	100 LPM
	0.8 MM
	125 ML
	CE
	8 424835 001711

Pistola pintar gravedad HVLP-I HVLP-I gravity paint spray gun

Pistola pintar gravidade HVLP-I

Cuerpo de aluminio
Acabado cromado y pulido
Agarre ergonómico
Regulador de abanico
Regulador de fluido
Regulador de presión
Incluye kit de limpieza

Aluminium body
Polished chrome finish
Ergonomic grip
Pattern regulator
Fluid regulator
Pressure regulator
Includes cleaning kit











Corpo de alumínio
Acabamento cromado e polido
Agarramento ergonómico
Regulador de leque
Regulador de fluido
Regulador de pressão
Inclui kit de limpeza



HVLP-I (alto volumen a baja presión) reduce el consumo del producto a pulverizar un 30%, acorta el tiempo de trabajo un 20%, disminuye el consumo de aire un 15% y genera una buena calidad de pulverización y acabado.

HVLP-I (high volume at low pressure) reduces the consumption of the product to be sprayed by 30%, shortens the working time by 20%, reduces air consumption by 15% and generates a good quality of spray and finish.

HVLP-I (alto volumen a baixa pressão) reduz o consumo do produto a ser pulverizado em 30%, reduz o tempo de trabalho em 20%, reduz o consumo de ar em 15% e gera uma boa qualidade de pulverização e acabamento.

	WK500740 10 / 001-019.000
	≥ 1.5 HP
	3 - 4 BAR
	8 BAR
	BSP 1/4"
	175 LPM
	1.7 MM
	600 ML
	CE
	8 424835 001728

Pistola pintar succión HVLP-I

HVLP-I suction paint spray gun

Pistola pintar sucção HVLP-I

Cuerpo de aluminio
Acabado cromado y pulido
Agarre ergonómico
Regulador de abanico
Regulador de fluido
Regulador de presión
Incluye kit de limpieza

Aluminium body
 Polished chrome finish
 Ergonomic grip
 Pattern regulator
 Fluid regulator
 Pressure regulator
 Includes cleaning kit

Corpo de alumínio
 Acabamento cromado e polido
 Agarramento ergonômico
 Regulador de leque
 Regulador de fluido
 Regulador de pressão
 Inclui kit de limpeza



	WK500750 10 / 001-020.000
	≥ 2 HP
	3 - 4 BAR
	8 BAR
	BSP 1/4"
	175 LPM
	1.7 MM
	1000 ML
	CE
	8 424835 001735

HVLP-I (alto volumen a baja presión) reduce el consumo del producto a pulverizar un 30%, acorta el tiempo de trabajo un 20%, disminuye el consumo de aire un 15% y genera una buena calidad de pulverización y acabado.

HVLP-I (high volume at low pressure) reduces the consumption of the product to be sprayed by 30%, shortens the working time by 20%, reduces air consumption by 15% and generates a good quality of spray and finish.

HVLP-I (alto volumen a baixa pressão) reduz o consumo do produto a ser pulverizado em 30%, reduz o tempo de trabalho em 20%, reduz o consumo de ar em 15% e gera uma boa qualidade de pulverização e acabamento.

Pistola pintar gravedad retoques HVLP-II

HVLP-II retouch gravity paint spray gun

Pistola pintar gravidade retoques HVLP-II

Cuerpo de aluminio
Acabado cromado mate
Agarre ergonómico
Regulador de abanico
Regulador de fluido
Regulador de presión
Incluye kit de limpieza

Aluminium body
 Matt chrome finish
 Ergonomic grip
 Pattern regulator
 Fluid regulator
 Pressure regulator
 Includes cleaning kit

Corpo de alumínio
 Acabamento cromado mate
 Agarramento ergonómico
 Regulador de leque
 Regulador de fluido
 Regulador de pressão
 Inclui kit de limpeza



HVLP-II (alto volumen a baja presión) reduce el consumo del producto a pulverizar un 40%, acorta el tiempo de trabajo un 30%, disminuye el consumo de aire un 40% y genera una buena calidad de pulverización y acabado.

HVLP-II (high volume at low pressure) reduces the consumption of the product to be sprayed by 40%, shortens the working time by 30%, reduces air consumption by 40% and generates a good quality of spray and finish.

HVLP-II (alto volumen a baixa pressão) reduz o consumo do produto a ser pulverizado em 40%, reduz o tempo de trabalho em 30%, reduz o consumo de ar em 40% e gera uma boa qualidade de pulverização e acabamento.

	WK501100 30 / 001-020.000
	≥ 1.5 HP
	1 - 2.5 BAR
	8 BAR
	BSP 1/4"
	75 LPM
	0.8 MM
	125 ML
	CE
	8 424835 009410

Pistola pintar gravedad HVLP-II

HVLP-II gravity paint spray gun

Pistola pintar gravidade HVLP-II

Cuerpo de aluminio
Acabado cromado mate
Agarre ergonómico
Regulador de abanico
Regulador de fluido
Regulador de presión
Incluye kit de limpieza

Aluminium body
 Matt chrome finish
 Ergonomic grip
 Pattern regulator
 Fluid regulator
 Pressure regulator
 Includes cleaning kit

Corpo de alumínio
 Acabamento cromado mate
 Agarramento ergonómico
 Regulador de leque
 Regulador de fluido
 Regulador de pressão
 Inclui kit de limpeza



HVLP-II (alto volumen a baja presión) reduce el consumo del producto a pulverizar un 40%, acorta el tiempo de trabajo un 30%, disminuye el consumo de aire un 40% y genera una buena calidad de pulverización y acabado.

HVLP-II (high volume at low pressure) reduces the consumption of the product to be sprayed by 40%, shortens the working time by 30%, reduces air consumption by 40% and generates a good quality of spray and finish.

HVLP-II (alto volumen a baixa pressão) reduz o consumo do produto a ser pulverizado em 40%, reduz o tempo de trabalho em 30%, reduz o consumo de ar em 40% e gera uma boa qualidade de pulverização e acabamento.

	WK501080 10 / 001-026.000
	≥ 1.5 HP
	1.5 - 3 BAR
	8 BAR
	BSP 1/4"
	125 LPM
	1.7 MM
	600 ML
	CE
	8 424835 009397

Pistola pintar succión HVLP-II

HVLP-II suction paint spray gun

Pistola pintar sucção HVLP-II

Cuerpo de aluminio
Acabado cromado mate
Agarre ergonómico
Regulador de abanico
Regulador de fluido
Regulador de presión
Incluye kit de limpieza

Aluminium body
Matt chrome finish
Ergonomic grip
Pattern regulator
Fluid regulator
Pressure regulator
Includes cleaning kit

Corpo de alumínio
Acabamento cromado mate
Agarramento ergonômico
Regulador de leque
Regulador de fluido
Regulador de pressão
Inclui kit de limpeza



	WK501090 10 / 001-027.000
	≥ 2 HP
	1.5 - 3 BAR
	8 BAR
	BSP 1/4"
	125 LPM
	1.7 MM
	1000 ML
	CE
	8 424835 009403

HVLP-II (alto volumen a baja presión) reduce el consumo del producto a pulverizar un 40%, acorta el tiempo de trabajo un 30%, disminuye el consumo de aire un 40% y genera una buena calidad de pulverización y acabado.

HVLP-II (high volume at low pressure) reduces the consumption of the product to be sprayed by 40%, shortens the working time by 30%, reduces air consumption by 40% and generates a good quality of spray and finish.

HVLP-II (alto volumen a baixa pressão) reduz o consumo do produto a ser pulverizado em 40%, reduz o tempo de trabalho em 30%, reduz o consumo de ar em 40% e gera uma boa qualidade de pulverização e acabamento.

Pistola pintar gravedad retoques HVLP-III

HVLP-III retouch gravity paint spray gun

Pistola pintar gravidade retoques HVLP-III

Cuerpo de aluminio
Acabado electroforético
Agarre ergonómico
Regulador de abanico
Regulador de fluido
Regulador de presión
Incluye kit de limpieza
Incluye maletín de transporte

Aluminium body
Electrophoretic finish
Ergonomic grip
Pattern regulator
Fluid regulator
Pressure regulator
Includes cleaning kit
Includes transportation case











Corpo de alumínio
Acabamento eletroforético
Agarramento ergonômico
Regulador de leque
Regulador de fluido
Regulador de pressão
Inclui kit de limpeza
Inclui mala de transporte



HVLP-III (alto volumen, baja presión) reduce el consumo del producto a pulverizar un 50%, acorta el tiempo de trabajo un 40%, disminuye el consumo de aire un 50% y genera una excelente calidad de pulverización y acabado, todo ello con una baja presión de fluido.

HVLP-III (high volume, low pressure) reduces the consumption of the product to be sprayed by 50%, shortens the working time by 40%, reduces air consumption by 50% and generates an excellent quality of spray and finish.

HVLP-III (alto volume, baixa pressão) reduz o consumo do produto a ser pulverizado em 50%, reduz o tempo de trabalho em 40%, reduz o consumo de ar em 50% e gera uma qualidade excelente de pulverização e acabamento.

	WK501000 5 / 001-0054.000
	≥ 1.5 HP
	1 - 2.5 BAR
	10 BAR
	BSP 1/4"
	50 LPM
	0.8 / 1.0 MM
	125 ML
	CE
	8 424835 009373

Pistola pintar gravedad HVLP-III

HVLP-III gravity paint spray gun

Pistola pintar gravidade HVLP-III

Cuerpo de aluminio
Acabado electroforético
Agarre ergonómico
Regulador de abanico
Regulador de fluido
Regulador de presión
Incluye kit de limpieza
Incluye maletín de transporte

Aluminium body
Electrophoretic finish
Ergonomic grip
Pattern regulator
Fluid regulator
Pressure regulator
Includes cleaning kit
Includes transportation case











Corpo de alumínio
Acabamento eletroforético
Agarramento ergonômico
Regulador de leque
Regulador de fluido
Regulador de pressão
Inclui kit de limpeza
Inclui mala de transporte



HVLP-III (alto volumen, baja presión) reduce el consumo del producto a pulverizar un 50%, acorta el tiempo de trabajo un 40%, disminuye el consumo de aire un 50% y genera una excelente calidad de pulverización y acabado, todo ello con una baja presión de fluido.

HVLP-III (high volume, low pressure) reduces the consumption of the product to be sprayed by 50%, shortens the working time by 40%, reduces air consumption by 50% and generates an excellent quality of spray and finish.

HVLP-III (alto volume, baixa pressão) reduz o consumo do produto a ser pulverizado em 50%, reduz o tempo de trabalho em 40%, reduz o consumo de ar em 50% e gera uma qualidade excelente de pulverização e acabamento.

	WK500470 5 / 001-0068.000
	≥ 1.5 HP
	1.5 - 3 BAR
	10 BAR
	BSP 1/4"
	100 LPM
	1.3 / 1.5 MM
	600 ML
	CE
	8 424835 007966

Pistola pintar succión HVLP-III

HVLP-III suction paint spray gun

Pistola pintar sucção HVLP-III

Cuerpo de aluminio
Acabado electroforético
Agarre ergonómico
Regulador de abanico
Regulador de fluido
Regulador de presión
Incluye kit de limpieza
Incluye maletín de transporte

Aluminium body
 Electrophoretic finish
 Ergonomic grip
 Pattern regulator
 Fluid regulator
 Pressure regulator
 Includes cleaning kit
 Includes transportation case

Corpo de alumínio
 Acabamento eletroforético
 Agarramento ergonômico
 Regulador de leque
 Regulador de fluido
 Regulador de pressão
 Inclui kit de limpeza
 Inclui mala de transporte



	WK500480 5 / 001-069.000
	≥ 2 HP
	1.5 - 3 BAR
	10 BAR
	BSP 1/4"
	100 LPM
	1.3 / 1.5 MM
	1000 ML
	CE
	8 424835 007973

HVLP-III (alto volumen, baja presión) reduce el consumo del producto a pulverizar un 50%, acorta el tiempo de trabajo un 40%, disminuye el consumo de aire un 50% y genera una excelente calidad de pulverización y acabado, todo ello con una baja presión de fluido.

HVLP-III (high volume, low pressure) reduces the consumption of the product to be sprayed by 50%, shortens the working time by 40%, reduces air consumption by 50% and generates an excellent quality of spray and finish.

HVLP-III (alto volume, baixa pressão) reduz o consumo do produto a ser pulverizado em 50%, reduz o tempo de trabalho em 40%, reduz o consumo de ar em 50% e gera uma qualidade excelente de pulverização e acabamento.

Pistola pintar gravedad gotelé

Gravity hopper paint spray gun

Pistola pintar gravidade gotelé

Cuerpo de aluminio

Acabado cromado y pulido

Agarre ergonómico

Regulador de fluido

Regulador de presión

Válvula integrada de corte de aire

Aluminium body

Polished chrome finish

Ergonomic grip

Fluid regulator

Pressure regulator

Integrated air cut valve

Corpo de alumínio

Acabamento cromado e polido

Agarramento ergonómico

Regulador de fluido

Regulador de pressão

Válvula integrada de corte de ar



	WK500660 6 / 001-024.000
	≥ 2 HP
	4 - 8 BAR
	8 BAR
	BSP 1/4"
	300 LPM
	4 / 6 / 8 MM
	6000 ML
	CE
	8 424835 001766

Juego pistolas pintar gravedad HVLP-I

HVLP-I gravity paint spray gun set

Jogo pistolas pintar gravidade HVLP-I

Cuerpo de acero

Acabado cromado y pulido

Agarre ergonómico

Regulador de abanico

Regulador de fluido

Regulador de presión

Incluye manómetro

Incluye kit de limpieza

Incluye maletín de transporte

Steel body

Polished chrome finish

Ergonomic grip

Pattern regulator

Fluid regulator

Pressure regulator

Includes manometer

Includes cleaning kit

Includes transportation case

Corpo de aço

Acabamento cromado e polido

Agarramento ergonómico

Regulador de leque

Regulador de fluido

Regulador de pressão

Inclui manômetro

Inclui kit de limpeza

Inclui mala de transporte



	WK500230 10 / 001-035.000
	≥ 1.5 HP
	2.5 - 3.5 / 3 - 4 BAR
	8 BAR
	BSP 1/4"
	100 / 175 LPM
	0.8 / 1.7 MM
	125 / 600 ML
	CE
	8 424835 006426

HVLP-I (alto volumen a baja presión) reduce el consumo del producto a pulverizar un 30%, acorta el tiempo de trabajo un 20%, disminuye el consumo de aire un 15% y genera una buena calidad de pulverización y acabado.

HVLP-I (high volume at low pressure) reduces the consumption of the product to be sprayed by 30%, shortens the working time by 20%, reduces air consumption by 15% and generates a good quality of spray and finish.

HVLP-I (alto volumen a baixa pressão) reduz o consumo do produto a ser pulverizado em 30%, reduz o tempo de trabalho em 20%, reduz o consumo de ar em 15% e gera uma boa qualidade de pulverização e acabamento.

Juego paso fluido

Fluid nozzle set

Jogo passagem fluido





Cuerpo de acero inoxidable
Incluye pico fluido, boquilla y aguja

Stainless-steel body
Includes cap, nozzle and needle

Corpo de aço inoxidável
Inclui bico fluido, boquilha e agulha



WK500730

	WK500010 6 / 001-002.400	WK500020 6 / 001-002.400	WK500030 6 / 001-002.400
	BSP 1"	BSP 1"	BSP 1"
	0.5 MM	0.8 MM	1.0 MM
	8 424835 502515	8 424835 000554	8 424835 000561

Juego paso fluido

Fluid nozzle set

Jogo passagem fluido





Cuerpo de acero inoxidable
Incluye pico fluido, boquilla y aguja

Stainless-steel body
Includes cap, nozzle and needle

Corpo de aço inoxidável
Inclui bico fluido, boquilha e agulha



WK500740

	WK500040 6 / 001-002.800	WK500050 6 / 001-002.800	WK500060 6 / 001-002.800
	BSP 1/3"	BSP 1/3"	BSP 1/3"
	1.4 MM	1.7 MM	2.0 MM
	8 424835 000905	8 424835 000516	8 424835 000912

Juego paso fluido

Fluid nozzle set

Jogo passagem fluido





Cuerpo de acero inoxidable
Incluye pico fluido, boquilla y aguja

Stainless-steel body
Includes cap, nozzle and needle

Corpo de aço inoxidável
Inclui bico fluido, boquilha e agulha



WK500750

	WK500070 6 / 001-003.000	WK500090 6 / 001-003.000	WK500100 6 / 001-003.000
	BSP 1/3"	BSP 1/3"	BSP 1/3"
	1.4 MM	1.7 MM	2.0 MM
	8 424835 000929	8 424835 002299	8 424835 002244

Juego paso fluido

Fluid nozzle set

Jogo passagem fluido

WK501100

Cuerpo de acero inoxidable
Incluye pico fluido, boquilla y aguja

Stainless-steel body
Includes cap, nozzle and needle

Corpo de aço inoxidável
Inclui bico fluido, boquilha e agulha



	WK501130 6 / 001-004.000	WK501140 6 / 001-004.000	WK501150 6 / 001-004.000
	BSP 1"	BSP 1"	BSP 1"
	0.5 MM	0.8 MM	1.0 MM
	8 424835 009489	8 424835 009496	8 424835 009502

Juego paso fluido

Fluid nozzle set

Jogo passagem fluido

WK501080

Cuerpo de acero inoxidable
Incluye pico fluido, boquilla y aguja

Stainless-steel body
Includes cap, nozzle and needle

Corpo de aço inoxidável
Inclui bico fluido, boquilha e agulha



	WK501020 6 / 001-004.400	WK501030 6 / 001-004.400	WK501040 6 / 001-004.400
	BSP 1/3"	BSP 1/3"	BSP 1/3"
	1.4 MM	1.7 MM	2.0 MM
	8 424835 009427	8 424835 009434	8 424835 009441

Juego paso fluido

Fluid nozzle set

Jogo passagem fluido

WK501090

Cuerpo de acero inoxidable
Incluye pico fluido, boquilla y aguja

Stainless-steel body
Includes cap, nozzle and needle

Corpo de aço inoxidável
Inclui bico fluido, boquilha e agulha



	WK501050 6 / 001-004.600	WK501060 6 / 001-004.600	WK501070 6 / 001-004.600
	BSP 1/3"	BSP 1/3"	BSP 1/3"
	1.4 MM	1.7 MM	2.0 MM
	8 424835 009458	8 424835 009465	8 424835 009472

Filtro pistola pintar gravedad
Gravity paint spray gun filter
 Filtro pistola pintar gravidade





Cuerpo de HDPE y acero inoxidable
Compatible con pistolas de pintar de gravedad universales

HDPE and stainless-steel body
 Compatible with universal gravity paint spray guns

Corpo de HDPE e aço inoxidável
 Compatível com pistolas de pintar por gravidade universais



- 
WK500730
WK500740
WK501100
WK501080
WK501000
WK500470
WK500230

	WK500250 6 / 006-001.800
	36 MM
	11 MM
PCS	10
	8 424835 006464

Depósito gravedad
Gravity cup
 Depósito gravidade





Cuerpo de HDPE
Compatible con pistolas de pintar de gravedad universales

HDPE body
 Compatible with universal gravity paint spray guns

Corpo de HDPE
 Compatível com pistolas de pintar por gravidade universais



- 
WK500730
WK500740
WK501100
WK501080
WK501000
WK500470
WK500230

	WK500170 6 / 001-002.000	WK500180 6 / 001-003.200
	125 ML	600 ML
	BSP 3/8"	BSP 1/2"
	8 424835 003463	8 424835 003470

Pulverizador cemento-estuco

Cement-stucco sprayer

Pulverizador cimento-estruque

Cuerpo de aluminio

Agarre ergonómico antideslizante

Mango auxiliar

Incluye 4 boquillas integradas

Aluminium body

Ergonomic non-slip grip

Auxiliary handle

Includes 4 built-in tips











Corpo de alumínio

Agarramento ergonômico antiderrapante

Cabo auxiliar

Inclui 4 boquilhas integradas



	WK500920 2 / 001-058.000
	≥ 2 HP
	5 - 8 BAR
	8 BAR
	BSP 1/4"
	225 - 375 LPM
	14 MM
	6000 ML
	700 MM
	CE
	8 424835 009021

Recomendable para trabajos en superficies de hasta 2000 m². Compatible con cementos, masillas, morteros, yesos y estucos.

Recommended for works on surfaces up to 2000 m². Compatible with cements, putties, mortars, plasters and stuccos.

Recomendado para trabalhos em superfícies de até 2000 m². Compatível com cimentos, massas, argamassas, gessos e estuques.

Equipo eléctrico airless

Airless electric equipment

Equipamento elétrico airless

Cuerpo de ABS y aluminio

Agarre ergonómico antideslizante

Regulador de fluido

Regulador de presión

Fácilmente transportable

Incluye pistola de pintar airless WK500490

Incluye manguera airless de 7.5 metros

Incluye depósito antigoteo extraíble

ABS and aluminium body

Ergonomic non-slip grip

Fluid regulator

Pressure regulator

Easily transportable

Includes airless paint spray gun WK500490

Includes 7.5-meter airless hose

Includes removable non-drip cup

Corpo de ABS e alumínio

Agarramento ergonómico antiderrapante

Regulador de fluido

Regulador de pressão

Facilmente transportável

Inclui pistola de pintar airless WK500490

Inclui mangueira airless de 7.5 metros

Inclui depósito antigotejamento removível



	WK500500 1 / 001-242.000
	0.7 HP / 500 W
	120 - 170 BAR
	205 BAR
	NPS 1/4"
	1.2 LPM
	≤ 0.019"
	5 ≤ 40° C
	CE
	8 424835 008352

Recomendable para trabajos en superficies de hasta 500 m². Compatible con barnices, lacas, esmaltes, imprimaciones, pinturas de poliuretano, pinturas acrílicas, pinturas plásticas y pinturas de caucho acrílico.

Recommended for works on surfaces up to 500 m². Compatible with varnishes, lacquers, enamels, primers, polyurethane paints, acrylic paints, plastic paints and acrylic rubber paints.

Recomendado para trabalhos em superfícies de até 500 m². Compatível com vernizes, lacas, esmaltes, primers, tintas de poliuretano, tintas acrílicas, tintas plásticas e tintas de borracha acrílica.

Equipo eléctrico airless

Airless electric equipment

Equipamento elétrico airless

Cuerpo de ABS y aluminio

Agarre ergonómico antideslizante

Regulador de fluido

Regulador de presión

Fácilmente transportable

Incluye manómetro

Incluye pistola de pintar airless WK500600

Incluye manguera airless de 15 metros

Incluye alargador de 500 mm

Incluye depósito antigoteo extraíble

ABS and aluminium body

Ergonomic non-slip grip

Fluid regulator

Pressure regulator

Easily transportable

Includes manometer

Includes airless paint spray gun WK500600

Includes 15-meter airless hose

Includes 500 mm extension bar

Includes removable non-drip cup

Corpo de ABS e alumínio

Agarramento ergonômico antiderrapante

Regulador de fluido

Regulador de pressão

Facilmente transportável

Inclui manômetro

Inclui pistola de pintar airless WK500600

Inclui mangueira airless de 15 metros

Inclui extensão de 500 mm

Inclui depósito antigotejamento removível



Recomendable para trabajos en superficies de hasta 1000 m². Compatible con barnices, lacas, esmaltes, imprimaciones, pinturas de poliuretano, pinturas acrílicas, pinturas plásticas, pinturas de caucho acrílico, pinturas al látex y temple.

Recommended for works on surfaces up to 1000 m². Compatible with varnishes, lacquers, enamels, primers, polyurethane paints, acrylic paints, plastic paints, acrylic rubber paints, latex paints and temperas.

Recomendado para trabalhos em superfícies de até 1000 m². Compatível com vernizes, lacas, esmaltes, primers, tintas de poliuretano, tintas acrílicas, tintas plásticas, tintas de borracha acrílica, tintas o látex e têmperas.

	WK500900 1 / 001-524.000
	0.7 HP / 500 W
	120 - 180 BAR
	225 BAR
	NPS 1/4"
	1.8 LPM
	≤ 0.021"
	5 ≤ 40° C
	CE
	8 424835 008475

Equipo eléctrico airless

Airless electric equipment

Equipamento elétrico airless

Cuerpo de ABS y aluminio

Agarre ergonómico antideslizante

Regulador de fluido

Regulador de presión con display digital

Fácilmente transportable

Incluye pistola de pintar airless WK500600

Incluye manguera airless de 15 metros

Incluye alargador de 500 mm

Incluye depósito antigoteo extraíble

ABS and aluminium body

Ergonomic non-slip grip

Fluid regulator

Pressure regulator with digital display

Easily transportable

Includes airless paint spray gun WK500600

Includes 15-meter airless hose

Includes 500 mm extension bar

Includes removable non-drip cup

Corpo de ABS e alumínio

Agarramento ergonômico antiderrapante

Regulador de fluido

Regulador de pressão com display digital

Facilmente transportável

Inclui pistola de pintar airless WK500600

Inclui mangueira airless de 15 metros

Inclui extensão de 500 mm











Inclui depósito antigotejamento removível



Recomendable para trabajos en superficies de hasta 1500 m². Compatible con barnices, lacas, esmaltes, imprimaciones, pinturas de poliuretano, pinturas acrílicas, pinturas plásticas, pinturas de caucho acrílico, pinturas al látex, temple, revestimientos de techados y pinturas anticorrosivas.

Recommended for works on surfaces up to 1500 m². Compatible with varnishes, lacquers, enamels, primers, polyurethane paints, acrylic paints, plastic paints, acrylic rubber paints, latex paints, temperas, roof coatings and anticorrosive paints.

Recomendado para trabalhos em superfícies de até 1500 m². Compatível com vernizes, lacas, esmaltes, primers, tintas de poliuretano, tintas acrílicas, tintas plásticas, tintas de borracha acrílica, tintas o látex, temperas, coberturas de telhado e tintas anticorrosivas.

	WK501110 1 / 001-648.000
	2.2 HP / 1600 W
	120 - 180 BAR
	225 BAR
	NPS 1/4"
	3 LPM
	≤ 0.023"
	5 ≤ 40° C
	CE
	8 424835 009342

Equipo eléctrico airless

Airless electric equipment

Equipamento elétrico airless

Cuerpo de ABS y aluminio

Ruedas de PU de 200 mm

Asa plegable

Regulador de fluido

Regulador de presión con display digital

Motor sin escobillas

Fácilmente transportable

Incluye pistola de pintar airless WK500600

Incluye manguera airless de 15 metros

Incluye alargador de 500 mm

ABS and aluminium body

PU wheels of 200 mm

Foldable handle

Fluid regulator

Pressure regulator with digital display

Brushless motor

Easily transportable

Includes airless paint spray gun WK500600

Includes 15-meter airless hose

Includes 500 mm extension bar

Corpo de ABS e alumínio

Rodas de PU de 200 mm

Asa dobrável

Regulador de fluido

Motor sem escovas

Regulador de pressão com display digital

Fácilmente transportável

Inclui pistola de pintar airless WK500600

Inclui mangueira airless de 15 metros

Inclui extensão de 500 mm



Recomendable para trabajos en superficies de hasta 3000 m². Compatible con barnices, lacas, esmaltes, imprimaciones, pinturas de poliuretano, pinturas acrílicas, pinturas plásticas, pinturas de caucho acrílico, pinturas al látex, temple, revestimientos de tejados, pinturas anticorrosivas y películas gruesas.

Recommended for works on surfaces up to 3000 m². Compatible with varnishes, lacquers, enamels, primers, polyurethane paints, acrylic paints, plastic paints, acrylic rubber paints, latex paints, temple, roof coatings, anticorrosive paints and thick layers.

Recomendado para trabalhos em superfícies de até 3000 m². Compatível com vernizes, lacas, esmaltes, primers, tintas de poliuretano, tintas acrílicas, tintas plásticas, tintas de borracha acrílica, tintas o látex, têmperas, coberturas de telhado, tintas anticorrosivas e películas espesas.

	WK501120 1 / 001-868.000
	3.8 HP / 2800 W
	120 - 180 BAR
	225 BAR
	NPS 1/4"
	4 LPM
	≤ 0.027"
	5 ≤ 40° C
	CE
	8 424835 009359

Equipo eléctrico airless

Airless electric equipment

Equipamento elétrico airless

Cuerpo de ABS y aluminio

Ruedas neumáticas de PU 300 de mm

Asa extensible

Regulador de fluido

Regulador de presión con display digital

Motor sin escobillas

Fácilmente transportable

Incluye pistola de pintar airless WK500600

Incluye manguera airless de 30 metros

Incluye alargador de 1 metro

ABS and aluminium body

Pneumatic PU wheels of 300 mm

Extendable handle

Fluid regulator

Pressure regulator with digital display

Brushless motor

Easily transportable

Includes airless paint spray gun WK500600

Includes 30-meter airless hose

Includes 1-meter extension bar

Corpo de ABS e alumínio

Rodas pneumáticas de PU de 300 mm

Asa extensível

Regulador de fluido

Regulador de pressão com display digital

Motor sem escovas











Facilmente transportável

Inclui pistola de pintar airless WK500600

Inclui mangueira airless de 30 metros

Inclui extensão de 1 metro



	WK501200 1 / 001-2250.000
	4 HP / 3000 W
	120 - 180 BAR
	225 BAR
	NPS 1/4"
	5 LPM
	≤ 0.031"
	5 ≤ 40° C
	CE
	8 424835 009816



Recomendable para trabajos en superficies de hasta 5000 m². Compatible con barnices, lacas, esmaltes, imprimaciones, pinturas de poliuretano, pinturas acrílicas, pinturas plásticas, pinturas de caucho acrílico, pinturas al látex, temple, revestimientos de tejados, pinturas anticorrosivas y películas gruesas.

Recommended for works on surfaces up to 5000 m². Compatible with varnishes, lacquers, enamels, primers, polyurethane paints, acrylic paints, plastic paints, acrylic rubber paints, latex paints, temperas, roof coatings, anticorrosive paints and thick layers.

Recomendado para trabalhos em superfícies de até 5000 m². Compatível com vernizes, lacas, esmaltes, primers, tintas de poliuretano, tintas acrílicas, tintas plásticas, tintas de borracha acrílica, tintas o látex, têmperas, coberturas de telhado, tintas anticorrosivas e películas espesas.

Equipo hidráulico airless a gasolina

Gasoline airless hydraulic equipment

Equipamento hidráulico airless a gasolina

Cuerpo de ABS, aluminio y acero forjado

Ruedas neumáticas de caucho de 330 mm

Asa extensible

Regulador de presión

Motor de gasolina

Bomba hidráulica

Fácilmente transportable

Incluye pistola de pintar airless WK501360

Incluye mangueras airless de 3.6 y 15 metros

ABS, aluminium and forged steel body

Pneumatic rubber wheels of 330 mm

Extendable handle

Pressure regulator

Gasoline motor

Hydraulic pump

Easily transportable

Includes airless paint spray gun WK501360

Includes 3.6 and 15-meter airless hoses

Corpo de ABS, alumínio e aço forjado

Rodas pneumáticas de borracha de 330 mm

Asa extensível

Regulador de pressão

Motor de gasolina











Bomba hidráulica

Facilmente transportável

Inclui pistola de pintar airless WK501360

Inclui mangueiras airless de 3.6 e 15 metros



	WK501400 1 / 001-2970.000
	9 HP / 6700 W
	120 - 180 BAR
	225 BAR
	NPS 1/2"
	12 LPM
	≤ 0.057"
	5 ≤ 40° C
	CE
	8 424835 010102



Recomendable para trabajos en superficies de más de 5000 m². Compatible con barnices, lacas, esmaltes, imprimaciones, pinturas de poliuretano, pinturas acrílicas, pinturas plásticas, pinturas de caucho acrílico, pinturas al látex, temple, revestimientos de tejados, pinturas anticorrosivas, películas gruesas y masillas.

Recommended for works on surfaces of more than 5000 m². Compatible with varnishes, lacquers, enamels, primers, polyurethane paints, acrylic paints, plastic paints, acrylic rubber paints, latex paints, temperas, roof coatings, anticorrosive paints, thick layers and putties.

Recomendado para trabalhos em superfícies de mais de 5000 m². Compatível com vernizes, lacas, esmaltes, primers, tintas de poliuretano, tintas acrílicas, tintas plásticas, tintas de borracha acrílica, tintas o látex, têmperas, coberturas de telhado, tintas anticorrosivas, películas espesas e massas.

Pistola pintar airless

Airless paint spray gun

Pistola pintar airless

Cuerpo de aluminio

Agarre ergonómico antideslizante

Mango con protector de puño

Compatible con RAC-5 de Graco

Incluye portaboquillas

Incluye boquilla 517

Aluminium body

Ergonomic non-slip grip

Fist protector handle

Compatible with RAC-5 from Graco

Includes tip holder

Includes 517 tip

Corpo de alumínio

Agarramento ergonómico antiderrapante

Cabo com protector de punho

Compatível com RAC-5 de Graco

Inclui porta-boquilhas

Inclui boquilha 517



Pistola pintar airless

Airless paint spray gun

Pistola pintar airless

Cuerpo de aluminio

Agarre ergonómico antideslizante

Mango con protector de puño

Compatible con RAC-5 de Graco

Incluye portaboquillas

Incluye boquilla 517

Aluminium body

Ergonomic non-slip grip

Fist protector handle

Compatible with RAC-5 from Graco

Includes tip holder

Includes 517 tip

Corpo de alumínio

Agarramento ergonómico antiderrapante

Cabo com protector de punho

Compatível com RAC-5 de Graco

Inclui porta-boquilhas









Inclui boquilha 517



Compatible con barnices, lacas, esmaltes, imprimaciones, pinturas de poliuretano, pinturas acrílicas, pinturas plásticas, pinturas de caucho acrílico, pinturas al látex, temple, revestimientos de tejados, pinturas anticorrosivas y películas gruesas.

Compatible with varnishes, lacquers, enamels, primers, polyurethane paints, acrylic paints, plastic paints, acrylic rubber paints, latex paints, temperas, roof coatings, anticorrosive paints and thick layers.









Compatível com vernizes, lacas, esmaltes, primers, tintas de poliuretano, tintas acrílicas, tintas plásticas, tintas de borracha acrílica, tintas o látex, têmperas, coberturas de telhado, tintas anticorrosivas e películas espesas.

	WK500490 20 / 001-026.000
	≥ 0.5 HP / 375 W
	60 - 160 BAR
	250 BAR
	NPS 1/4"
	BSP 7/8"
	5 ≤ 40° C
	CE
	8 424835 008345

Compatible con barnices, lacas, esmaltes, imprimaciones, pinturas de poliuretano, pinturas acrílicas, pinturas plásticas y pinturas de caucho acrílico.

Compatible with varnishes, lacquers, enamels, primers, polyurethane paints, acrylic paints, plastic paints and acrylic rubber paints.

Compatível com vernizes, lacas, esmaltes, primers, tintas de poliuretano, tintas acrílicas, tintas plásticas e tintas de borracha acrílica.

	WK500600 20 / 001-044.000
	≥ 0.5 HP / 375 W
	60 - 160 BAR
	250 BAR
	NPS 1/4"
	BSP 7/8"
	5 ≤ 40° C
	CE
	8 424835 008338

Pistola pintar airless

Airless paint spray gun

Pistola pintar airless

Cuerpo de aluminio

Agarre ergonómico antideslizante

Mango con protector de puño

Compatible con RAC-XHD de Graco

Incluye portaboquillas

Incluye boquilla 643

Aluminium body

Ergonomic non-slip grip

Fist protector handle

Compatible with RAC-XHD from Graco

Includes tip holder

Includes 643 tip

Corpo de alumínio

Agarramento ergonômico antiderrapante

Cabo com protector de punho

Compatível com RAC-XHD de Graco

Inclui porta-boquilhas









Inclui boquilha 643



Compatible con barnices, lacas, esmaltes, imprimaciones, pinturas de poliuretano, pinturas acrílicas, pinturas plásticas, pinturas de caucho acrílico, pinturas al látex, templets, revestimientos de tejados, pinturas anticorrosivas, películas gruesas y masillas.

Compatible with varnishes, lacquers, enamels, primers, polyurethane paints, acrylic paints, plastic paints, acrylic rubber paints, latex paints, temperas, roof coatings, anticorrosive paints, thick layers and putties.

Compatível com vernizes, lacas, esmaltes, primers, tintas de poliuretano, tintas acrílicas, tintas plásticas, tintas de borracha acrílica, tintas o látex, têmperas, coberturas de telhado, tintas anticorrosivas, películas espesas e massas.

	WK501360 20 / 001-052.000
	≥ 1 HP / 750 W
	90 - 210 BAR
	310 BAR
	NPS 3/8"
	BSP 7/8"
	5 ≤ 40° C
	CE
	8 424835 010119

Pistola pintar airless in-line

In-line airless paint spray gun

Pistola pintar airless in-line

Cuerpo de aluminio

Agarre ergonómico antideslizante

Mango con protector de puño

Compatible con RAC-5 de Graco

Incluye portaboquillas

Incluye boquilla 517

Aluminium body

Ergonomic non-slip grip

Fist protector handle

Compatible with RAC-5 from Graco

Includes tip holder

Includes 517 tip

Corpo de alumínio

Agarramento ergonómico antiderrapante









Cabo com protector de punho

Compatível com RAC-5 de Graco

Inclui porta-boquilhas

Inclui boquilha 517



	WK501500 20 / 001-050.000
	≥ 0.5 HP / 375 W
	80 - 160 BAR
	250 BAR
	NPS 1/4"
	BSP 7/8"
	5 ≤ 40° C
	CE
	8 424835 010584

Compatible con barnices, lacas, esmaltes, imprimaciones, pinturas de poliuretano, pinturas acrílicas, pinturas plásticas, pinturas de caucho acrílico, pinturas al látex, temple, revestimientos de tejados, pinturas anticorrosivas y películas gruesas.

Compatible with varnishes, lacquers, enamels, primers, polyurethane paints, acrylic paints, plastic paints, acrylic rubber paints, latex paints, temperas, roof coatings, anticorrosive paints and thick layers.

Compatível com vernizes, lacas, esmaltes, primers, tintas de poliuretano, tintas acrílicas, tintas plásticas, tintas de borracha acrílica, tintas o látex, têmperas, coberturas de telhado, tintas anticorrosivas e películas espesas.

Pistola pintar airless aire-asistido

Air-assisted airless paint spray gun

Pistola pintar airless ar-assistido

Cuerpo de aluminio

Agarre ergonómico

Mango con protector de puño

Compatible con RAC-5 de Graco

Incluye portaboquillas

Incluye boquilla 517

Aluminium body

Ergonomic grip

Fist protector handle

Compatible with RAC-5 from Graco

Includes tip holder

Includes 517 tip

Corpo de alumínio

Agarramento ergonômico

Cabo com protector de punho

Compatível com RAC-5 de Graco

Inclui porta-boquilhas









Inclui boquilha 517



Compatible con barnices, lacas, esmaltes, imprimaciones, pinturas de poliuretano, pinturas acrílicas, pinturas plásticas, pinturas de caucho acrílico, pinturas al látex, temples, revestimientos de techados, pinturas anticorrosivas y películas gruesas.

Compatible with varnishes, lacquers, enamels, primers, polyurethane paints, acrylic paints, plastic paints, acrylic rubber paints, latex paints, temperas, roof coatings, anticorrosive paints and thick layers.

Compatível com vernizes, lacas, esmaltes, primers, tintas de poliuretano, tintas acrílicas, tintas plásticas, tintas de borracha acrílica, tintas o látex, têmperas, coberturas de telhado, tintas anticorrosivas e películas espesas.

	WK501540 20 / 001-074.000
	≥ 0.5 HP / 375 W
	80 - 160 BAR
	230 BAR
	NPS 1/4"
	BSP 7/8"
	5 ≤ 40° C
	CE
	8 424835 010591

Boquilla pistola pintar airless

Airless paint spray gun tip

Boquilha pistola pintar airless

Cuerpo de carburo tungsteno

Compatible con RAC-5 de Graco

Incluye junta de sellado de boquilla

Tungsten carbide body



Compatible with RAC-5 from Graco



Includes tip seal gasket



Corpo de carburado tungstênio



Compatível com RAC-5 de Graco



Inclui junta de selado de boquilha



	WK501170 6 / 001-008.200	WK500930 6 / 001-008.200
	211	213
	8 424835 009786	8 424835 009281

	WK500880 6 / 001-008.200	WK500890 6 / 001-008.200	WK500940 6 / 001-008.200
	313	315	317
	8 424835 008536	8 424835 008543	8 424835 009298

	WK501370 6 / 001-008.200	WK500540 6 / 001-008.200	WK500550 6 / 001-008.200	WK500560 6 / 001-008.200	WK500570 6 / 001-008.200	WK500950 6 / 001-008.200
	413	415	417	419	421	423
	8 424835 010126	8 424835 008437	8 424835 008444	8 424835 008451	8 424835 008468	8 424835 009304

	WK501380 6 / 001-008.200	WK500630 6 / 001-008.200	WK500640 6 / 001-008.200	WK500650 6 / 001-008.200	WK500860 6 / 001-008.200	WK500970 6 / 001-008.200
	513	515	517	519	521	523
	8 424835 010133	8 424835 008505	8 424835 008512	8 424835 008529	8 424835 008482	8 424835 009328

	WK501390 6 / 001-008.200	WK501180 6 / 001-008.200	WK501190 6 / 001-008.200	WK501210 6 / 001-008.200	WK501220 6 / 001-008.200	WK501230 6 / 001-008.200
	613	615	617	619	621	623
	8 424835 010140	8 424835 009793	8 424835 009809	8 424835 009823	8 424835 009830	8 424835 009847

	WK501250 6 / 001-008.200	WK501260 6 / 001-008.200
	723	725
	8 424835 009861	8 424835 009878



WK500490
WK500600
WK501500
WK501540



	WK500960 6 / 001-008.200	WK501410 6 / 001-008.200	WK501440 6 / 001-008.200
	425	427	429
	8 424835 009311	8 424835 010157	8 424835 010188

	WK500980 6 / 001-008.200	WK501420 6 / 001-008.200	WK501450 6 / 001-008.200
	525	527	529
	8 424835 009335	8 424835 010164	8 424835 010195

	WK501240 6 / 001-008.200	WK501430 6 / 001-008.200	WK501460 6 / 001-008.200
	625	627	629
	8 424835 009854	8 424835 010171	8 424835 010201

El primer número indica el ángulo. Por ejemplo, 5 corresponde a 50°. Para obtener el ancho del abanico, multiplique el número del ángulo por 5. Por ejemplo, 5x5=25 cm. Los segundos dos números indican el flujo de pintura. Por ejemplo, 17 corresponde a un diámetro de 0.017".

The first number indicates the angle. For example, 5 corresponds to 50°. To obtain the fan width, multiply the angle number by 5. In this case, 5x5=25 cm. The second two numbers indicate the paint flow. For example, 17 corresponds to a diameter of 0.017".

O primeiro número indica o ângulo. Por exemplo, 5 corresponde a 50°. Para obter a largura do leque, multiplique o número do ângulo por 5. Neste caso, 5x5=25 cm. Os segundos dois números indicam o fluxo de tinta. Por exemplo, 17 corresponde a um diâmetro de 0.017".

Boquilla pistola pintar airless

Airless paint spray gun tip

Boquilha pistola pintar airless



Cuerpo de carburo tungsteno
Compatible con RAC-XHD de Graco
Incluye junta de sellado de boquilla

Tungsten carbide body
 Compatible with RAC-XHD from Graco
 Includes tip seal gasket

Corpo de carburado tungstênio
 Compatível com RAC-XHD de Graco
 Inclui junta de selado de boquilha



El primer número indica el ángulo. Por ejemplo, 5 corresponde a 50°. Para obtener el ancho del abanico, multiplique el número del ángulo por 5. Por ejemplo, 5x5=25 cm. Los segundos dos números indican el flujo de pintura. Por ejemplo, 17 corresponde a un diámetro de 0.017".

The first number indicates the angle. For example, 5 corresponds to 50°. To obtain the fan width, multiply the angle number by 5. In this case, 5x5=25 cm. The second two numbers indicate the paint flow. For example, 17 corresponds to a diameter of 0.017".

O primeiro número indica o ângulo. Por exemplo, 5 corresponde a 50°. Para obter a largura do leque, multiplique o número do ângulo por 5. Neste caso, 5x5=25 cm. Os segundos dois números indicam o fluxo de tinta. Por exemplo, 17 corresponde a um diâmetro de 0.017".

	WK501470 6 / 001-008.200	WK501480 6 / 001-008.200
	535	539
	8 424835 010218	8 424835 010225

	WK501490 6 / 001-008.200	WK501510 6 / 001-008.200	WK501520 6 / 001-008.200	WK501530 6 / 001-008.200
	635	639	643	647
	8 424835 010232	8 424835 010249	8 424835 010256	8 424835 010263

Portaboquillas giratorio pistola pintar airless

Airless paint spray gun swivel tip holder

Porta-boquilhas giratório pistola pintar airless

Cuerpo de acero inoxidable

Compatible con RAC-5 y RAC-XHD de Graco

Incluye portaboquillas y boquilla 517

Stainless-steel body

Compatible with RAC-5 and RAC-XHD from Graco

Includes tip holder and 517 tip

Corpo de aço inoxidável

Compatível com RAC-5 e RAC-XHD de Graco

Inclui porta-boquilhas e boquilha 517



	WK500870 6 / 001-022.000
	BSP 7/8"
	250 BAR
	-5 ≤ 65° C
	270°
	8 424835 008499

Portaboquillas pistola pintar airless

Airless paint spray gun tip holder

Porta-boquilhas pistola pintar airless

Cuerpo de acero inoxidable

Compatible con RAC-5 y RAC-XHD de Graco

Stainless-steel body

Compatible with RAC-5 and RAC-XHD from Graco

Corpo de aço inoxidável

Compatível com RAC-5 e RAC-XHD de Graco



	WK500460 6 / 001-006.000
	BSP 7/8"
	250 BAR
	-5 ≤ 65° C
	8 424835 008406

Junta sellado boquilla airless

Airless tip seal gasket

Junta selado boquilha airless

Cuerpo de acero y teflón

Compatible con RAC-5 y RAC-XHD de Graco

Steel and teflon body

Compatible with RAC-5 and RAC-XHD from Graco

Corpo de aço e teflon

Compatível com RAC-5 e RAC-XHD de Graco



	WK501350 12 / 001-005.600
PCS	5
	8 424835 010270

Filtro malla airless

Airless mesh filter

Filtro malha airless

Cuerpo de HDPE y acero inoxidable

Compatible con pistolas airless de Graco y Wagner

HDPE and stainless-steel body

Compatible with Graco and Wagner airless paint spray guns

Corpo de HDPE e aço inoxidável

Compatível com pistolas airless de Graco e Wagner

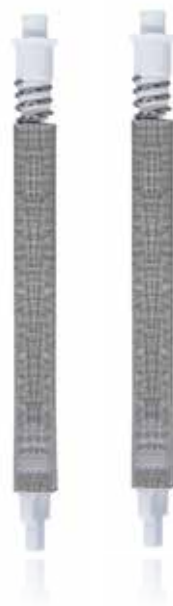

Ø I	WK501310 6 / 006-001.600	WK501320 6 / 006-001.600
■	#60	#100
↑ ↓	110-130 MM	110-130 MM
∅	10 MM	10 MM
PCS	2	2
	8 424835 009922	8 424835 009939

Filtro malla airless

Airless mesh filter

Filtro malha airless

Cuerpo de HDPE y acero inoxidable

Compatible con pistolas airless de Graco y Wagner

HDPE and stainless-steel body

Compatible with Graco and Wagner airless paint spray guns

Corpo de HDPE e aço inoxidável

Compatível com pistolas airless de Graco e Wagner

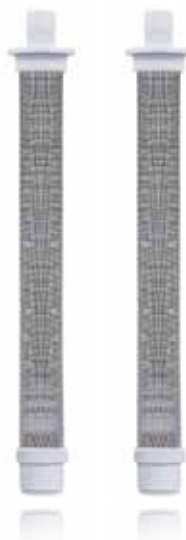

Ø I	WK501270 6 / 006-001.600	WK501280 6 / 006-001.600	WK501290 6 / 006-001.600	WK501300 6 / 006-001.600
■	#50	#80	#100	#150
↑ ↓	102 MM	102 MM	102 MM	102 MM
∅	10 MM	10 MM	10 MM	10 MM
PCS	2	2	2	2
	8 424835 009885	8 424835 009892	8 424835 009908	8 424835 009915

Alargador pistola pintar airless

Airless paint spray gun extension bar

Alargador pistola pintar airless

Cuerpo de aluminio
Incluye protectores de rosca

Aluminium body
 Includes thread protectors

Corpo de alumínio
 Inclui protetores de rosca



Ø L	WK500510 5 / 001-004.400	WK500520 5 / 001-005.400	WK501330 5 / 001-007.400	WK501340 5 / 001-011.400
↕	300 MM	600 MM	1000 MM	1800 MM
∅	5 X 12 MM	5 X 12 MM	5 X 12 MM	5 X 12 MM
→ ←	BSP 7/8"	BSP 7/8"	BSP 7/8"	BSP 7/8"
⊙ MAX	280 BAR	280 BAR	280 BAR	280 BAR
°C	-5 ≤ 65° C	-5 ≤ 65° C	-5 ≤ 65° C	-5 ≤ 65° C
	8 424835 008314	8 424835 008321	8 424835 009571	8 424835 009588

Manguera airless

Airless hose

Mangueira airless

Cuerpo de caucho y fibra de vidrio
Conexiones de rosca hembra
Ligera y flexible

Rubber and fibreglass body
 Female thread connections
 Light and flexible

Corpo de borracha e fibra de vidro
 Conexões de rosca fêmea
 Leve e flexível



Ø L	WK500610 5 / 001-025.000	WK500620 3 / 001-040.000
↕	7.5 M	15 M
∅	6 X 13 MM	6 X 13 MM
→ ←	NPS 1/4"	NPS 1/4"
⊙ MAX	225 BAR	225 BAR
°C	-5 ≤ 65° C	-5 ≤ 65° C
	8 424835 008413	8 424835 008420

Pistola soplar

Blowing gun

Pistola soprar

Cuerpo de aluminio

Acabado cromado y pulido

Agarre ergonómico

Regulador de fluido

Aluminium body

Polished chrome finish

Ergonomic grip

Fluid regulator









Corpo de alumínio

Acabamento cromado e polido

Agarramento ergonómico

Regulador de fluido



	WK500260 10 / 005-003.200
	≥ 0.5 HP
	6 - 7 BAR
	8 BAR
	BSP 1/4"
	300 LPM
	CE
	8 424835 002251

Pistola chorro arena

Sandblasting gun

Pistola jato areia

Cuerpo de acero carbono

Agarre antideslizante

Incluye 2 boquillas y manguera de succión de arena de 900 mm

Carbon steel body

Non-slip grip









Includes 2 nozzles and 900 mm sand suction hose

Corpo de aço carbono

Agarramento antiderrapante

Inclui 2 boquilhas e mangueira de sucção de areia de 900 mm



	WK500690 20 / 001-012.000
	≥ 1.5 HP
	4-5 BAR
	6 BAR
	BSP 1/4"
	280 LPM
	6 MM
	CE
	8 424835 007430

Pistola espuma

Foam gun

Pistola espuma

Cuerpo de aluminio y mango de caucho
Agarre ergonómico antideslizante
Compatible con cartuchos universales
Exterior e interior totalmente recubierto de teflón

Aluminium body and rubber handle
 Ergonomic non-slip grip
 Compatible with universal cartridges
 Fully teflon coated exterior and interior

Corpo de alumínio e punho de borracha
 Agarramento ergonômico antiderrapante
 Compatível com cartuchos universais
 Exterior e interior totalmente revestidos de teflon



	WK501160 20 / 001-008.200
	6 - 7 BAR
	14 BAR
	190 MM
	8 424835 009694

El revestimiento de teflón proporciona una excelente protección contra el pegado de la espuma y facilita la limpieza.

The teflon coating provides an excellent protection against foam sticking and makes cleaning easy.

O revestimento de teflon oferece uma excelente proteção contra a aderência da espuma e facilita a limpeza.

Lijadora circular orbital

Orbital circular sander

Lixadora circular orbital

Cuerpo de ABS
Sistema de extracción compatible con aspirador
Función de giro orbital
Fijación con velcro
Incluye manguera de aspiración de 1 metro

ABS body
 Extraction system compatible with vacuum cleaner
 Orbital spin function
 Velcro fixing
 Includes 1-meter suction hose

Corpo de ABS
 Sistema de extracção compatible com aspirador
 Função de rotação orbital
 Fixação com velcro
 Inclui mangueria de sucção de 1 metro



	WK500290 12 / 001-030.000
	≥ 2 HP
	4-5 BAR
	6 BAR
	BSP 1/4"
	200 LPM
	10500 RPM
	150 MM
	5 MM
	CE
	8 424835 001940

Filtro aire

Air filter





Filtro ar

Cuerpo de aluminio y policarbonato

Aluminium and polycarbonate body

Corpo de alumínio e policarbonato



	WK500320 10 / 001-003.200
	BSP 1/4"
	≤ 1000 LPM
	10 BAR
	8 424835 007089

Lubricador aire

Air lubricator





Lubrificador ar

Cuerpo de latón y policarbonato

Brass and polycarbonate body

Corpo de latão e policarbonato



	WK500330 10 / 001-002.200
	BSP 1/4"
	≤ 1000 LPM
	10 BAR
	8 424835 007096

Regulador aire

Air regulator

Regulador ar

Cuerpo de aluminio y ABS

Medición en BAR y PSI







Aluminium and ABS body

BAR and PSI measure

Corpo de alumínio e ABS

Medição em BAR e PSI



	WK500340 10 / 001-005.800
	BSP 1/4"
	≤ 1000 LPM
	0-10 BAR
	12 BAR
	8 424835 007102

Filtro-regulador aire

Air filter-regulator

Filtro-regulador ar

Cuerpo de policarbonato

Medición en BAR y PSI

Polycarbonate body

BAR and PSI measure

Corpo de policarbonato

Medição em BAR e PSI



	WK500300 05 / 001-010.000
	BSP 1/2"
	≤ 1500 LPM
	0-10 BAR
	12 BAR
	10 MIC
	5-60° C
	125 ML
	8 424835 007065

Filtro-regulador-lubricador aire

Air filter-regulator-lubricator

Filtro-regulador-lubrificador ar

Cuerpo de policarbonato

Medición en BAR y PSI

Polycarbonate body

BAR and PSI measure

Corpo de policarbonato

Medição em BAR e PSI



	WK500310 05 / 001-017.000
	BSP 1/2"
	≤ 1500 LPM
	0-10 BAR
	12 BAR
	10 MIC
	5-60° C
	125 / 125 ML
	8 424835 007072

Enchufe rápido
Quick coupler
Plugue rápido

Cuerpo de acero inoxidable
Conexión de rosca hembra

Stainless-steel body
Female thread connection

Corpo de aço inoxidável
Conexão de rosca fêmea



Enchufe rápido
Quick coupler
Plugue rápido

Cuerpo de acero inoxidable
Conexión de rosca macho

Stainless-steel body
Male thread connection

Corpo de aço inoxidável
Conexão de rosca macho



	WK500380 20 / 005-002.600
	BSP 1/4"
	8 424835 007164

	WK500990 20 / 005-002.600
	BSP 1/4"
	8 424835 009366

Racor rápido
Quick fitting
União rápida

Cuerpo de acero inoxidable
Conexión de rosca hembra

Stainless-steel body
Female thread connection

Corpo de aço inoxidável
Conexão de rosca fêmea



Racor rápido
Quick fitting
União rápida

Cuerpo de acero inoxidable
Conexión de rosca macho

Stainless-steel body
Male thread connection

Corpo de aço inoxidável
Conexão de rosca macho



	WK501010 20 / 005-000.800
	BSP 1/4"
	8 424835 009380

	WK500390 20 / 005-000.800
	BSP 1/4"
	8 424835 007171

Racor rápido
Quick fitting
União rápida

Cuerpo de acero inoxidable
Conexión de espiga

Stainless-steel body
Barb connection

Corpo de aço inoxidável
Conexão de espiga



	WK500400 20 / 005-000.800	WK500410 20 / 005-000.900	WK500420 20 / 005-001.000
	8 MM	10 MM	12 MM
	8 424835 007188	8 424835 007195	8 424835 007201

Espiral manguera neumática

Pneumatic coiled hose







Espiral mangueira pneumática

Cuerpo de poliuretano
Conexiones de rosca macho
Ligera y flexible

Polyurethane body
Male thread connections
Light and flexible

Corpo de poliuretano
Conexões de rosca macho
Leve e flexível



	WK500190 10 / 001-006.500	WK500200 10 / 001-009.500
	10 M	15 M
	5 X 8 MM	5 X 8 MM
	BSP 1/4"	BSP 1/4"
	10 BAR	10 BAR
	-5 ≤ 60° C	-5 ≤ 65° C
	8 424835 000639	8 424835 003586

Manguera neumática

Pneumatic hose







Mangueira pneumática

Cuerpo de poliuretano y PVC
Conexiones de rosca macho
Ligera y flexible

Poliurethane and PVC body
Male thread connections
Light and flexible

Corpo de poliuretano e PVC
Conexões de rosca macho
Leve e flexível



	WK500360 10 / 001-014.000	WK500370 10 / 001-019.000
	10 M	15 M
	8 X 15 MM	8 X 15 MM
	BSP 1/4"	BSP 1/4"
	20 BAR	20 BAR
	-5 ≤ 60° C	-5 ≤ 65° C
	8 424835 002305	8 424835 000660

Herramientas manuales

Hand tools

Ferramentas manuais



Pistola cartuchos skeleton

Skeleton caulking gun

Pistola cartuchos skeleton

Cuerpo de aluminio y acero carbono
Varilla interior de alta aleación
Émbolo reforzado de 4 mm
Compatible con cartuchos universales
Función anti-goteo

Aluminium and carbon steel body
High alloy inner rod
Reinforced piston of 4 mm
Compatible with universal cartridges
No-drip function

Corpo de alumínio e aço carbono
Varinha interna de alta liga
Êmbolo reforçado de 4 mm
Compatível com cartuchos universais
Função anti-gotejamento



Pistola cartuchos

Caulking gun

Pistola cartuchos

Cuerpo de aluminio y acero carbono
Varilla interior de alta aleación
Émbolo reforzado de 9 mm
Mango y gatillo reforzados
Compatible con cartuchos universales
Función anti-goteo

Aluminium and carbon steel body
High alloy inner rod
Reinforced piston of 9 mm
Reinforced handle and trigger
Compatible with universal cartridges
No-drip function

Corpo de alumínio e aço carbono
Varinha interna de alta liga
Punho e gatilho reforçados
Êmbolo reforçado de 9 mm
Compatível com cartuchos universais
Função anti-gotejamento



	WK602410 24 / 001-003.200
	300 ML
	50 MM
	225 MM
	1500 N
	26:1
	8 424835 009953

	WK602420 12 / 001-006.600
	300 ML
	50 MM
	225 MM
	1800 N
	12:1
	8 424835 009960

Pistola cartuchos

Caulking gun

Pistola cartuchos

Cuerpo de aluminio y acero carbono
Varilla interior de alta aleación
Émbolo reforzado de 10 mm
Mango y gatillo reforzados
Compatible con cartuchos universales
Función anti-goteo

Aluminium and carbon steel body
 High alloy inner rod
 Reinforced piston of 10 mm
 Reinforced handle and trigger
 Compatible with universal cartridges
 No-drip function

Corpo de alumínio e aço carbono
 Varinha interna de alta liga
 Punho e gatilho reforçados
 Êmbolo reforçado de 10 mm
 Compatível com cartuchos universais
 Função anti-gotejamento



Pistola cartuchos tubular

Tubular caulking gun







Pistola cartuchos tubular







Cuerpo de aluminio
Varilla interior de alta aleación
Émbolo reforzado de 9 mm
Mango y gatillo reforzados
Grosor tubo aluminio de 1 mm
Compatible con cartuchos universales
Función anti-goteo
Incluye boquilla

Aluminium body
 High alloy inner rod
 Reinforced piston of 9 mm
 Reinforced handle and trigger
 Aluminium tube thickness of 1 mm
 Compatible with universal cartridges
 No-drip function
 Includes nozzle

Corpo de alumínio
 Varinha interna de alta liga
 Punho e gatilho reforçados
 Êmbolo reforçado de 9 mm
 Espessura do tubo de alumínio de 1 mm
 Compatível com cartuchos universais
 Função anti-gotejamento
 Inclui boquilha



	WK602430 12 / 001-009.500
	300 ML
	50 MM
	225 MM
	4000 N
	26:1
	8 424835 009977

	WK602440 12 / 001-008.600	WK602450 12 / 001-010.000
	300 ML	600 ML
	50 MM	50 MM
	225 MM	375 MM
	2500 N	2500 N
	18:1	18:1
	8 424835 009984	8 424835 009991

Espátula

Scraper

Espátula

Cuerpo de acero inoxidable

Mango de ABS

Tope de golpe metálico

Agarre ergonómico antideslizante

Stainless-steel body

ABS handle

Metallic hit end

Ergonomic non-slip grip

Corpo de aço inoxidável

Cabo de ABS

Tope de golpe metálico

Agarramento ergonómico antiderrapante



Ø I	WK600280 12 / 012-001.300	WK600290 12 / 012-001.350	WK600300 12 / 012-001.400	WK600310 12 / 012-001.450
↔	20 MM	30 MM	40 MM	50 MM
↑ ↓	90 MM	90 MM	90 MM	90 MM
∨ ∧	0.5 MM	0.5 MM	0.5 MM	0.5 MM
	8 424835 003715	8 424835 001452	8 424835 001469	8 424835 001476

Ø I	WK600320 12 / 012-001.500	WK600330 12 / 012-001.550	WK600340 12 / 012-001.600	WK600350 12 / 012-001.650	WK600360 12 / 012-001.700
↔	60 MM	70 MM	80 MM	90 MM	100 MM
↑ ↓	100 MM	100 MM	100 MM	100 MM	100 MM
∨ ∧	0.5 MM	0.5 MM	0.5 MM	0.5 MM	0.5 MM
	8 424835 002282	8 424835 002275	8 424835 000165	8 424835 000172	8 424835 000189

Espátula multifunción

Multi-function scraper

Espátula multifunção

Cuerpo de acero inoxidable

Mango de ABS

Tope de golpe metálico

Agarre ergonómico antideslizante

Stainless-steel body

ABS handle

Metallic hit end

Ergonomic non-slip grip

Corpo de aço inoxidável

Cabo de ABS

Tope de golpe metálico

Agarramento ergonómico antiderrapante



	WK600270 12 / 012-001.700
	70 MM
	110 MM
	0.5 MM
	8 424835 003708

Espátula yeso

Drywall scraper

Espátula gesso

Cuerpo de acero inoxidable - Mango de ABS

Puntas de atornillado de CV

Puntas de atornillado magnéticas

Tope de golpe metálico

Agarre ergonómico antideslizante

Incluye 2 puntas de atornillado

Stainless-steel body - ABS handle

CV screw bits

Magnetic screw bits

Metallic hit end

Ergonomic non-slip grip

Includes 2 screw bits

Corpo de aço inoxidável - Cabo de ABS

Puntas de aparafusado de CV

Puntas de aparafusado magnéticas

Tope de golpe metálico

Agarramento ergonómico antiderrapante

Inclui 2 puntas de aparafusado



	WK601700 12 / 006-003.200
	150 MM
	110 MM
	0.5 MM
	8 424835 006815

Juego espátulas enmasillar

Putty scraper set

Jogo espátulas enmasillar

Cuerpo de ABS

Agarre antideslizante

ABS body

Non-slip grip

Corpo de ABS

Agarramento antiderrapante



	WK601540 12 / 006-001.500
	50-120 MM
	110 MM
	3 MM
PCS	4
	8 424835 006310

Juego espátulas enmasillar

Putty scraper set

Jogo espátulas enmasillar

Cuerpo de acero

Mango de ABS

Agarre antideslizante

Steel body

ABS handle

Non-slip grip

Corpo de aço

Cabo de ABS

Agarramento antiderrapante



	WK601560 12 / 006-003.000
	50-120 MM
	110 MM
	3 MM
PCS	4
	8 424835 006327

Espátula emplastecer

Taping knife

Espátula amassar

Cuerpo de acero inoxidable

Mango y soporte de ABS

Agarre ergonómico antideslizante

Stainless-steel body

ABS handle and support

Ergonomic non-slip grip

Corpo de aço inoxidável

Cabo e suporte de ABS

Agarramento ergonómico antiderrapante



Ø l	WK600370 10 / 010-001.800	WK600380 10 / 010-001.900	WK600390 10 / 010-002.000
↔	120 MM	140 MM	160 MM
↑ ↓	90 MM	90 MM	90 MM
∨ ∧	0.5 MM	0.5 MM	0.5 MM
	8 424835 000509	8 424835 000592	8 424835 000523

Ø l	WK600400 10 / 010-002.100	WK600410 10 / 010-002.200	WK600420 10 / 010-002.300	WK600430 10 / 010-002.400
↔	180 MM	200 MM	220 MM	240 MM
↑ ↓	90 MM	90 MM	90 MM	90 MM
∨ ∧	0.5 MM	0.5 MM	0.5 MM	0.5 MM
	8 424835 000530	8 424835 000585	8 424835 000882	8 424835 000899

Espátula emplastecer

Taping knife

Espátula amassar

Cuerpo de acero inoxidable

Mango y soporte de ABS

Agarre ergonómico antideslizante

Uso lateral izquierda y derecha

Stainless-steel body

ABS handle and support

Ergonomic non-slip grip

Left and right lateral use

Corpo de aço inoxidável

Cabo e suporte de ABS

Agarramento ergonômico antiderrapante

Uso lateral esquerda e direita



Ø I	WK601820 10 / 005-003.200	WK601830 10 / 005-004.000	WK601840 10 / 005-004.800
←→	200 MM	250 MM	350 MM
↑ ↓	60 MM	60 MM	60 MM
∨ ∧	0.5 MM	0.5 MM	0.5 MM
	8 424835 007683	8 424835 007690	8 424835 007706

Espátula emplastecer

Taping knife

Espátula amassar

Cuerpo de acero azul

Mango de ABS y soporte de aluminio

Tope de golpe metálico

Agarre ergonómico antideslizante

Blue steel body

ABS handle and aluminium support

Metallic hit end

Ergonomic non-slip grip

Corpo de aço azul

Cabo de ABS e suporte de alumínio

Tope de golpe metálico

Agarramento ergonômico antiderrapante



Ø I	WK602250 6 / 006-003.000	WK602260 6 / 006-003.400	WK602270 6 / 006-003.800	WK602280 6 / 006-004.200	WK602290 6 / 006-004.600
←→	150 MM	200 MM	250 MM	300 MM	350 MM
↑ ↓	90 MM	90 MM	90 MM	90 MM	90 MM
∨ ∧	0.5 MM	0.5 MM	0.5 MM	0.5 MM	0.5 MM
	8 424835 009175	8 424835 009182	8 424835 009199	8 424835 009205	8 424835 009212

Espátula emplastecer

Taping knife

Espátula amassar

Cuerpo de acero inoxidable

Mango de aluminio

Agarre ergonómico antideslizante

Stainless-steel body

Aluminium handle

Ergonomic non-slip grip

Corpo de aço inoxidável

Cabo de alumínio

Agarramento ergonómico antiderrapante



Ø I	WK602510 10 / 001-016.000	WK602520 10 / 001-022.000	WK602530 10 / 001-028.000
↔	300 MM	500 MM	800 MM
↑ ↓	85 MM	85 MM	85 MM
∇ ∧	0.5 MM	0.5 MM	0.5 MM
	8 424835 010638	8 424835 010645	8 424835 010652

Juego espátulas emplastecer mango telescópico

Telescopic handle taping knife set

Jogo espátulas amassar cabo telescópico

Cuerpo de acero inoxidable

Mango de aluminio

Agarre ergonómico antideslizante

Incluye mango telescópico de aluminio de 850-2050 mm

Incluye 3 espátulas de emplastecer

Incluye 3 hojas de repuesto

Incluye maletín de transporte

Stainless-steel body

Aluminium handle

Ergonomic non-slip grip

Includes 850-2050 mm aluminium telescopic handle

Includes 3 taping knives

Includes 3 replacement blades

Includes transportation case

Corpo de aço inoxidável

Cabo de alumínio

Agarramento ergonômico antiderrapante

Inclui cabo telescópico de alumínio de 850-2050 mm

Inclui 3 espátulas de amassar

Inclui 3 lâminas de reposição

Inclui mala de transporte



0 1	WK602540 4 / 001-108.000
←→	300 / 500 / 800 MM
↑ ↓	85 MM
∨ ∧	0.5 MM
	8 424835 010669

Espátula ángulos exteriores

Exterior angle trowel

Espátula ângulos exteriores

Cuerpo de acero inoxidable

Mango de ABS

Agarre ergonómico antideslizante

Juntas con soldadura TIG

Stainless-steel body

ABS handle

Ergonomic non-slip grip

TIG welding joints

Corpo de aço inoxidável

Cabo de ABS

Agarramento ergonômico antiderrapante

Juntas com soldadura TIG



	WK602330 10 / 001-004.000
	100 MM
	90 MM
	0.5 MM
	8 424835 009632

Espátula ángulos interiores

Interior angle trowel

Espátula ângulos interiores

Cuerpo de acero inoxidable

Mango de ABS

Agarre ergonómico antideslizante

Juntas con soldadura TIG

Stainless-steel body

ABS handle

Ergonomic non-slip grip

TIG welding joints

Corpo de aço inoxidável

Cabo de ABS

Agarramento ergonômico antiderrapante

Juntas com soldadura TIG



	WK602340 10 / 001-004.000
	100 MM
	90 MM
	0.5 MM
	8 424835 009649

Llana decorador

Decorator trowel

Talocha decorador

Cuerpo de acero inoxidable

Mango de ABS

Agarre ergonómico antideslizante

Juntas con soldadura TIG

Stainless-steel body

ABS handle

Ergonomic non-slip grip

TIG welding joints

Corpo de aço inoxidável

Cabo de ABS

Agarramento ergonômico antiderrapante

Juntas com soldadura TIG



⊙ 	WK600960 12 / 001-003.800	WK601010 12 / 001-004.400
↕	200 MM	240 MM
↔	80 MM	110 MM
∨ ∧	0.6 MM	0.6 MM
	8 424835 006105	8 424835 006112

Llana rectangular

Rectangular trowel

Talocha rectangular

Cuerpo de acero inoxidable

Mango de ABS

Agarre ergonómico antideslizante

Juntas con soldadura TIG

Stainless-steel body

ABS handle

Ergonomic non-slip grip

TIG welding joints

Corpo de aço inoxidável

Cabo de ABS

Agarramento ergonômico antiderrapante

Juntas com soldadura TIG



⊙ 	WK600230 12 / 001-004.200	WK601060 12 / 001-004.800
↕	280 MM	300 MM
↔	120 MM	150 MM
∨ ∧	0.7 MM	0.7 MM
	8 424835 002862	8 424835 006129

Talocha rectangular

Rectangular trowel

Talocha rectangular

Cuerpo de ABS

Mango de madera

ABS body

Wooden handle

Corpo de ABS

Cabo de madeira



	WK600250 12 / 006-002.200
	270 MM
	180 MM
	10 MM
	8 424835 003579

Talocha rectangular

Rectangular trowel

Talocha rectangular

Cuerpo de poliestireno

Acolchado de esponja

Agarre ergonómico antideslizante

Polystyrene body

Sponge padding

Ergonomic non-slip grip

Corpo de poliestireno

Acolchado de esponja

Agarramento ergonómico antiderrapante



	WK601870 12 / 001-003.800
	280 MM
	140 MM
	30 MM
	8 424835 007874

Talocha rectangular

Rectangular trowel

Talocha rectangular

Cuerpo de aluminio

Mango de madera

Acolchado de EVA-goma

Agarre ergonómico antideslizante

Aluminium body

Wood handle

EVA-rubber padding

Ergonomic non-slip grip





Corpo de alumínio

Cabo de madeira

Acolchado de EVA-borracha

Agarramento ergonómico antiderrapante



	WK601890 12 / 001-004.600
	240 MM
	100 MM
	20 MM
	8 424835 007898

Talocha rectangular

Rectangular trowel

Talocha rectangular

Cuerpo de poliestireno

Acolchado de caucho-espuma

Agarre ergonómico antideslizante

Polystyrene body

Rubber-foam padding





Ergonomic non-slip grip

Corpo de poliestireno

Acolchado de borracha-espuma

Agarramento ergonómico antiderrapante



	WK601880 12 / 001-005.600
	280 MM
	140 MM
	20 MM
	8 424835 007881

Lijadora rectangular paredes

Rectangular wall sander

Lixadora rectangular paredes

Cuerpo de ABS

Acolchado de EVA

Agarre ergonómico

Fijación con clip de ajuste

ABS body

EVA padding

Ergonomic grip

Adjustment clip fixing

Corpo de ABS

Acolchado de EVA

Agarramento ergonómico

Fixação com clipe de ajuste



	WK600110 12 / 006-002.800
	210 MM
	105 MM
	4 MM
	8 424835 001193

Lijadora rectangular paredes

Rectangular wall sander

Lixadora rectangular paredes

Cuerpo de ABS

Acolchado de EVA

Agarre ergonómico

Fijación con clip de ajuste

ABS body

EVA padding

Ergonomic grip

Adjustment clip fixing

Corpo de ABS

Acolchado de EVA

Agarramento ergonómico

Fixação com clipe de ajuste



	WK600120 12 / 006-003.200
	230 MM
	105 MM
	6 MM
	8 424835 001087

Lijadora rectangular paredes-techos

Rectangular wall-ceiling sander

Lixadora rectangular paredes-tetos

Cuerpo de ABS

Acolchado de EVA

Cabezal orientable con rosca para mango

Fijación con clip de ajuste

ABS body

EVA padding

Adjustable head with handle thread

Adjustment clip fixing

Corpo de ABS

Acolchado de EVA

Cabeça ajustável com rosca para cabo

Fixação com clipe de ajuste



	WK600130 12 / 006-003.600
	210 MM
	105 MM
	6 MM
	180°
	8 424835 000875

Lijadora circular paredes-techos

Circular wall-ceiling sander

Lixadora circular paredes-tetos

Cuerpo de ABS

Cabezal orientable con rosca para mango

Fijación con velcro

Incluye 3 discos de lijado

ABS body

Adjustable head with handle thread

Velcro fixation

Includes 3 sanding disc

Corpo de ABS

Cabeça ajustável com rosca para cabo

Fixação com velcro

Inclui 3 discos de lixado



	WK601760 20 / 001-009.400
	225 MM
	8 MM
	180°
	8 424835 007386

Cepillo alambre

Wire brush

Escova arame

Cuerpo de ABS

Púas de acero inoxidable

Agarre ergonómico antideslizante

ABS body

Stainless-steel spikes





Ergonomic non-slip grip

Corpo de ABS

Púas de aço inoxidável

Agarramento ergonômico antiderrapante



	WK600050 12 / 006-001.200
	165 MM
	39
	20 MM
	8 424835 002565

Cepillo alambre

Wire brush

Escova arame

Cuerpo de ABS

Púas de acero carbono

Agarre ergonómico antideslizante

ABS body

Carbon steel spikes





Ergonomic non-slip grip

Corpo de ABS

Púas de aço carbono

Agarramento ergonômico antiderrapante



	WK600060 6 / 006-002.200	WK600070 6 / 006-002.800
	220 MM	280 MM
	48	72
	30 MM	30 MM
	8 424835 002701	8 424835 002619

Cepillo alambre

Wire brush

Escova arame

Cuerpo de ABS

Púas de acero carbono

Agarre ergonómico antideslizante

ABS body

Carbon steel spikes





Ergonomic non-slip grip

Corpo de ABS

Púas de aço carbono

Agarramento ergonômico antiderrapante



	WK600090 6 / 006-002.800	WK600100 6 / 006-003.200
	340 MM	340 MM
	76	114
	25 MM	25 MM
	8 424835 003494	8 424835 003500

Cepillo alambre

Wire brush

Escova arame

Cuerpo de ABS

Púas de acero carbono

Agarre ergonómico antideslizante

ABS body

Carbon steel spikes

Ergonomic non-slip grip

Corpo de ABS

Púas de aço carbono

Agarramento ergonômico antiderrapante



	WK600030 6 / 006-003.600
	210 MM
	96
	30 MM
	8 424835 002169

Escoba alambre

Wire broom

Vassoura arame

Agarre ergonómico antideslizante

Cabezal con rosca para mango

Púas de acero carbono

Ergonomic non-slip grip

Head with handle thread

Carbon steel spikes

Agarramento ergonômico antiderrapante

Cabeça com rosca para cabo

Púas de aço carbono



	WK600040 6 / 006-003.600
	180 MM
	65 MM
	114
	35 MM
	8 424835 002152

Sierra yeso

Drywall saw

Serra gesso

Hoja de acero inoxidable

Mango de ABS

Agarre ergonómico antideslizante

Incluye funda

Stainless-steel blade

ABS handle

Ergonomic non-slip grip

Includes holster

Folha de aço inoxidável

Cabo de ABS

Agarramento ergonômico antiderrapante

Inclui bainha



	WK601770 10 / 001-004.800
	160 MM
	10-22 MM
	1.5 MM
	38
	8 424835 007393

Sierra yeso plegable

Foldable drywall saw

Serra gesso dobrável

Hoja de acero inoxidable

Mango de ABS

Agarre ergonómico antideslizante

Plegable en 3 posiciones

Stainless-steel blade

ABS handle

Ergonomic non-slip grip

Foldable in 3 positions

Folha de aço inoxidável

Cabo de ABS

Agarramento ergonômico antiderrapante

Dobrável em 3 posições



	WK601780 10 / 001-006.800
	130 MM
	10-22 MM
	1.2 MM
	35
	8 424835 007409

Serrucho yeso

Drywall saw

Serra gesso

Hoja de acero carbono

Mango de ABS

Agarre ergonómico antideslizante

Carbon steel blade

ABS handle

Ergonomic non-slip grip

Folha de aço carbono

Cabo de ABS

Agarramento ergonômico antiderrapante



⊙ 	WK601980 12 / 001-005.000
↑ ↓	500 MM
← →	40-120 MM
∞	1 MM
∟	140 / 7x"
	8 424835 008550

Hacha-martillo yeso

Drywall axe-hammer

Machado-martelo gesso

Cabezal de acero carbono forjado

Cabezal tratado térmicamente para durezas extremas

Mango de fibra

Agarre ergonómico antideslizante

Cabezal con 2 funciones

Forged carbon steel head

Heat treated head for extreme hardnesses

Fiber handle

Ergonomic non-slip grip

2 function head

Cabeça de aço carbono forjado

Cabeça tratada termicamente para durezas extremas

Cabo de fibra

Agarramento ergonômico antiderrapante

Cabeçal com 2 funções



⊙ 	WK601710 10 / 001-006.000
↑ ↓	300 MM
⏚	600 GR
∅	175 X 28 X 25 MM
	8 424835 007942

Bolígrafo destornillador

Screwdriver pen

Caneta chave fenda

Cuerpo de ABS

Puntas de atornillado de CV

Puntas de atornillado magnéticas

Incluye 2 puntas de atornillado

ABS body

CV screwdriver bits

Magnetic screw bits

Includes 2 screw bits





Corpo de ABS

Pontas de aparafusado de CV

Pontas de aparafusado magnéticas

Inclui 2 pontas de aparafusado



	WK602000 96 / 012-001.600
	135 MM
	HEX-6
	PH0-1 / 3-4 MM
	8 424835 008574

Remachadora tacos metálicos expansión

Metallic expansion stud riveter

Remachadora tacos metálicos expansão

Cuerpo de acero carbono

Mango de caucho

Agarre ergonómico antideslizante

Carbon steel body

Rubber handle





Ergonomic non-slip grip

Corpo de aço carbono

Cabo de borracha

Agarramento ergonômico antiderrapante



	WK602370 40 / 001-006.800
	170 MM
	M-4 / M-5 / M-6
	8 424835 009717

Punta tope profundidad

Depth limit bit

Ponta tope profundidade

Punta de CV

Punta magnética





CV bit

Magnetic bit

Ponta de CV

Ponta magnética



	WK601930 12 / 012-002.000
	HEX-6
	PH2
PCS	6
	8 424835 008239

Portapuntas ajuste profundidad

Depth adjust bit holder

Portapuntas ajuste profundidade

Punta de CV

Punta magnética

Incluye punta de atornillado

CV bit

Magnetic bit





Includes screw bit

Ponta de CV

Ponta magnética

Inclui ponta de aparafusado



	WK601940 12 / 001-003.900
	HEX-6
	PH2
	8 424835 008246

Tijera corta chapa

Sheet cut snip

Tesoura corta chapa

Cuerpo de CV

Mango de caucho

Agarre ergonómico antideslizante

Incluye sistema de cierre

CV body

Rubber handle

Ergonomic non-slip grip

Includes closing system





Corpo de CV

Cabo de borracha

Agarramento ergonómico antiderrapante

Inclui sistema de fecho



	WK601950 36 / 001-005.200
	250 MM
	≤ 1.2 MM
	8 424835 008253

Cizalla corta chapa

Sheet cut shear

Cizalha corta chapa

Cuerpo de acero carbono

Mango de caucho

Agarre ergonómico antideslizante

Incluye cabezal rompe-recoge virutas

Incluye sistema de cierre

Carbon steel body

Rubber handle

Ergonomic non-slip grip

Includes chip breaker-collector

Includes closing system

Corpo de aço carbono





Cabo de borracha

Agarramento ergonómico antiderrapante

Inclui cabeça quebra-junta rebarbas

Inclui sistema de fecho



	WK602380 24 / 001-007.200
	260 MM
	≤ 1.2 MM
	8 424835 009724

Punzonadora perfiles

Profile stud crimper

Punçonadora perfis

Cuerpo de acero carbono

Mango de caucho

Agarre ergonómico antideslizante

Incluye sistema de cierre

Carbon steel body

Rubber handle

Ergonomic non-slip grip

Includes closing system





Corpo de aço carbono

Cabo de borracha

Agarramento ergonômico antiderrapante

Inclui sistema de fecho



	WK601970 24 / 001-013.000
	260 MM
	0.5-0.8 MM
	8 424835 008376

Punzonadora perfiles

Profile stud crimper

Punçonadora perfis

Cuerpo de acero carbono

Mango de caucho

Agarre ergonómico antideslizante

Carbon steel body

Rubber handle





Ergonomic non-slip grip

Corpo de aço carbono

Cabo de borracha

Agarramento ergonômico antiderrapante



	WK601960 24 / 001-014.000
	340 MM
	0.5-0.8 MM
	8 424835 008369

Sierra corona

Hole saw

Serra craneana

Compatible con madera, yeso y plástico

Incluye 12 sierras corona de acero carbono

Incluye 2 conectores

Incluye broca piloto

Incluye maletín de transporte

Compatible with wood, plaster and plastic

Includes 12 carbon steel hole saws

Includes 2 connectors

Includes pilot drill-bit

Includes transportation case

Compatível com madeira, gesso e plástico





Inclui 12 serras craneanas de aço carbono

Inclui 2 conectores

Inclui broca piloto

Inclui mala de transporte



	WK602060 12 / 001-008.400
	HEX-6 / HEX-8
	19-127 MM
	≤ 26 MM
	8 424835 008970

Broca sierra corona HSS

HSS hole saw drill-bit

Broca serra craneana HSS

Compatible con metal, acero inoxidable y aluminio

Incluye 5 sierras corona de HSS con brocas piloto





Compatible with metal, stainless-steel and aluminium

Includes 5 HSS hole saws with pilot drill-bits

Compatível com metal, aço inoxidável e alumínio

Inclui 5 serras craneanas de HSS com brocas piloto



	WK602120 12 / 001-011.000
	HEX-6-7-8
	16-30 MM
	≤ 8 MM
	8 424835 008994

Cortador circular ajustable

Adjustable circular cutter

Cortador circular ajustável

Compatible con madera, yeso y plástico

Incluye juego de cuchillas de corte de acero carbono

Incluye colector de polvo

Incluye broca piloto

Compatible with wood, plaster and plastic

Includes set of carbon steel cutting blades

Includes dust collector

Includes pilot drill-bit





Compatível com madeira, gesso e plástico

Inclui jogo de lâminas de corte de aço carbono

Inclui colector de pó

Inclui broca piloto



	WK602130 8 / 001-012.000
	HEX-8
	50-180 MM
	≤ 21 MM
	8 424835 009007

Cortador circular ajustable

Adjustable circular cutter

Cortador circular ajustável

Compatible con madera, yeso y plástico

Incluye 2 juegos de cuchillas de corte de HSS y acero tungsteno

Incluye colector de polvo y 2 brocas piloto

Incluye 5 brocas para hormigón y 5 brocas para madera

Incluye lápiz y flexómetro de 2 metros

Incluye maletín de transporte

Compatible with wood, plaster and plastic

Includes 2 sets of HSS and tungsten steel cutting blades

Includes dust collector and 2 pilot drill-bits

Includes 5 concrete drill-bits and 5 wood drill-bits

Includes pencil and 2-meter tape measure

Includes transportation case

Compatível com madeira, gesso e plástico

Inclui 2 jogos de lâminas de corte de HSS e aço tungstênio





Inclui colector de pó e 2 brocas piloto

Inclui 5 brocas para concreto e 5 brocas para madeira

Inclui lápis e flexómetro 2 metros

Inclui mala de transporte



	WK602070 10 / 001-052.000
	HEX-10
	30-300 MM
	≤ 30 MM
	8 424835 008987

Gavetilla yeso

Mud pan

Gavetilha gesso

Cuerpo de acero inoxidable

Agarre ergonómico antideslizante

Juntas reforzadas con soldadura TIG

Stainless-steel body

Ergonomic non-slip grip





Reinforced TIG welding joints

Corpo de aço inoxidável

Agarramento ergonômico antiderrapante

Juntas reforçadas com soldadura TIG



	WK602350 12 / 001-006.800
	360 X 110 X 90 MM
	0.7 MM
	2 L
	8 424835 009687

Dispensador-aplicador yeso

Drywall dispenser-applicator

Dispensador-aplicador gesso

Cuerpo de aluminio

Agarre ergonómico antideslizante

Cabezal orientable

Regulador de fluido

Extensible

Aluminium body

Ergonomic non-slip grip

Adjustable head

Fluid regulator

Extendable

Corpo de alumínio

Agarramento ergonômico antiderrapante

Cabeça ajustável

Regulador de fluido

Extensível

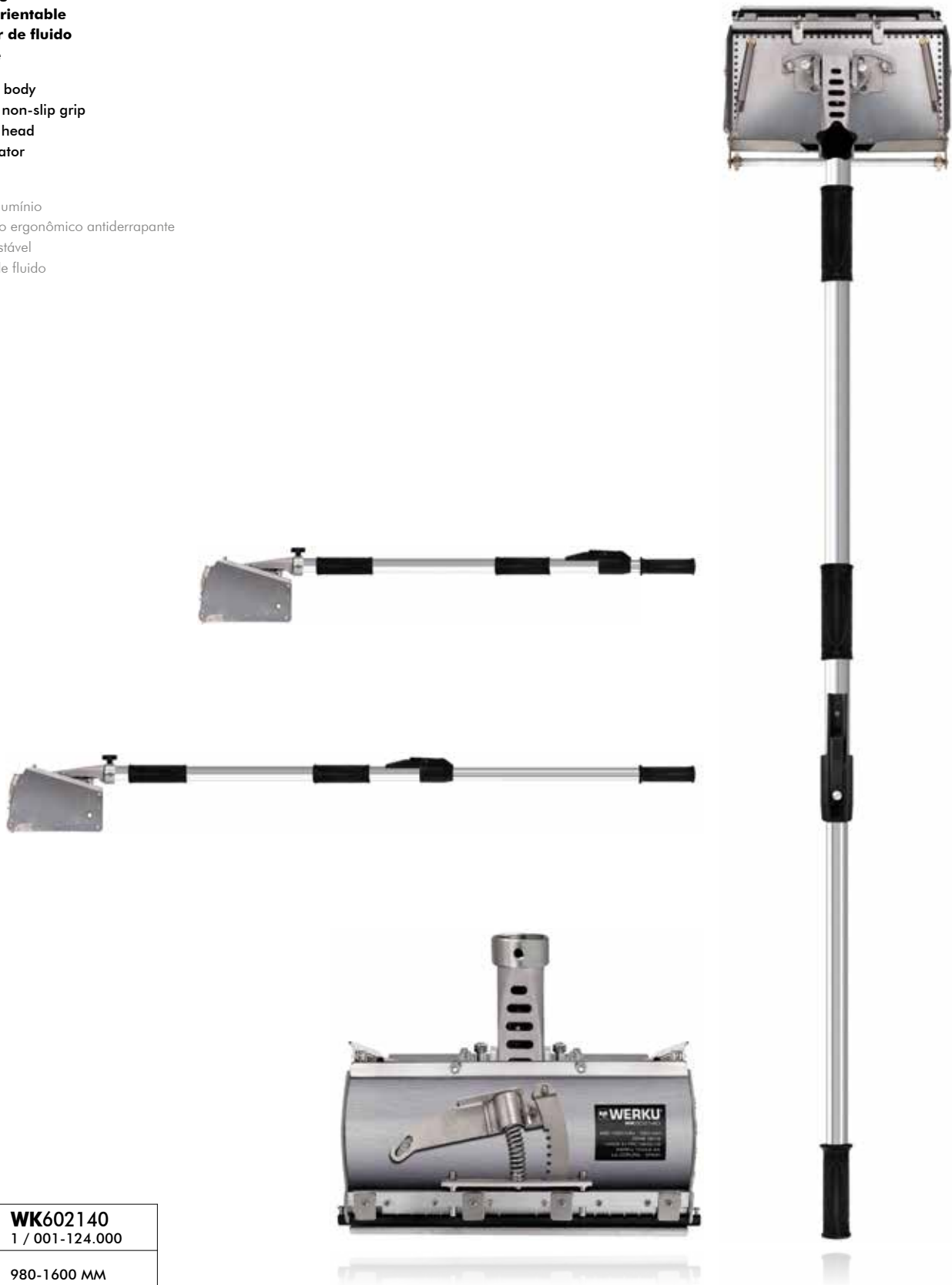

	WK602140 1 / 001-124.000
	980-1600 MM
	250 MM
	2 L
	90° / 360°
	8 424835 009069

Mordaza rápida

Quick clamp

Grampo rápido

Cuerpo de ABS

Barra de acero templado

Agarre ergonómico antideslizante

Soporte antideslizante

Almohadillas de protección

Liberación rápida

Función reversible

ABS body

Tempered steel bar

Ergonomic non-slip grip

Anti-slip support

Protection pads

Quick release

Reversible function

Corpo de ABS

Barra de aço temperado

Agarramento ergonômico antiderrapante

Suporte antiderrapagem

Almofadas de proteção

Liberação rápida

Função reversível



Ø	WK601900	WK601910	WK601920
1	12 / 001-008.400	12 / 001-009.400	12 / 001-010.400
↕	150 MM	300 MM	450 MM
👤	150 KG (daN)	150 KG (daN)	150 KG (daN)
⊘	5.8 X 3.3 MM	5.8 X 3.3 MM	5.8 X 3.3 MM
	8 424835 008130	8 424835 008147	8 424835 008154

Soporte extensible

Extendable support

Suporte extensível

Cuerpo de aluminio

Agarre ergonómico antideslizante

Soporte antideslizante

Cabezal orientable

Liberación rápida

Extensible

Aluminium body

Ergonomic non-slip grip

Anti-slip support

Adjustable head

Quick release

Extendable

Corpo de alumínio

Agarramento ergonômico antiderrapante







Suporte antiderrapagem

Cabeça ajustável

Liberação rápida

Extensível



	WK601720 10 / 001-016.000
	1150-2900 MM
	30 KG
	128 X 77 MM
	0-45°
	8 424835 008123

Carro-plataforma porta paneles-placas

Panel-board carrier trolley-platform

Carro-plataforma porta painéis-placas

Cuerpo de acero carbono

Ruedas castor de caucho de 120 mm

Ruedas traseras orientables en 360 grados

Fácilmente desmontable

Carbon steel body

Rubber castor wheels of 120 mm

Adjustable rear wheels in 360 degrees

Easy to disassemble







Corpo de aço carbono

Rodas castor de borracha de 120 mm

Rodas traseiras ajustáveis em 360 graus

Facilmente desmontable



	WK602360 1 / 001-139.000
	900 KG
	4880 X 1220 MM
	1060 X 320 MM
	1230 MM
	8 424835 009700

Porta paneles-placas

Panel-board carrier

Porta painéis-placas

Cuerpo de ABS

Agarre ergonómico antideslizante

Mango angular protector de nudillos

ABS body

Ergonomic non-slip grip







Knuckle protector angular handle

Corpo de ABS

Agarramento ergonômico antiderrapante

Cabo angular protetor nudillos



	WK602470 24 / 001-005.000
	80 KG
	4880 X 1220 MM
	165 MM
	370 MM
	8 424835 010027

Soporte paneles-placas

Panel-board holder

Suporte painéis-placas

Cuerpo de acero carbono

Altura de apoyo regulable





Carbon steel body

Adjustable support height

Corpo de aço carbono

Apoio de altura ajustável



	WK602500 4 / 001-020.000
	80 KG
	4880 X 1220 MM
	810 MM
	8 424835 010058

Elevador paneles

Panel lifter

Elevador painéis

Cuerpo de acero carbono

Ruedas castor de caucho de 120 mm

Ruedas orientables en 360 grados

Elevación horizontal y vertical

Carbon steel body

Rubber castor wheels of 120 mm

Adjustable wheels in 360 degrees

Horizontal and vertical lifting







Corpo de aço carbono

Rodas castor de borracha de 120 mm

Rodas ajustáveis em 360 graus

Elevação horizontal e vertical



	WK602150 1 / 001-175.000
	68 KG
	4880 X 1220 MM
	1220-3350 MM
	0-30°
	CE
	8 424835 009076

Elevador paneles

Panel lifter

Elevador painéis

Cuerpo de acero carbono

Plataforma de madera

Ruedas castor de caucho de 120 mm

Ruedas orientables en 360 grados

Elevación horizontal y vertical

Incluye barra de extensión adicional

Carbon steel body

Wooden platform

Rubber castor wheels of 120 mm

Adjustable wheels in 360 degrees

Horizontal and vertical lifting

Includes additional extension bar

Corpo de aço carbono

Plataforma de madeira







Rodas castor de borracha de 120 mm

Rodas ajustáveis em 360°

Elevação horizontal e vertical

Inclui barra de extensão adicional



	WK602160 1 / 001-382.000
	75 KG
	4880 X 1220 MM
	1450-3500/4000 MM
	0-30°
	CE
	8 424835 009083

Carro portacargas

Load carrier trolley

Carro porta-cargas

Cuerpo de acero carbono

Ruedas neumáticas de PU de 260 mm

Agarre ergonómico antideslizante

Carbon steel body

Pneumatic PU wheels of 260 mm

Ergonomic non-slip grip

Corpo de aço carbono

Rodas pneumáticas de PU de 260 mm

Agarramento ergonómico antiderrapante



	WK602310 1 / 001-040.000
	200 KG
	350 X 185 MM
	1165 MM
	TÜV GS
	8 424835 009601

Carro-plataforma portacargas

Load carrier trolley-platform

Carro-plataforma porta-cargas

Cuerpo de acero carbono

Asa de transporte acolchada de caucho

Plataforma de PU

Ruedas castor de PU de 125 mm

Ruedas traseras orientables en 360 grados

Agarre ergonómico antideslizante

Protección lateral contra impactos

Plegable

Carbon steel body

Rubber padded carrying handle

PU platform

PU castor wheels of 125 mm

Adjustable rear wheels in 360 degrees

Ergonomic non-slip grip

Side impact protection

Foldable

Corpo de aço carbono

Alça de transporte acolchoada de borracha

Plataforma de PU

Rodas castor de PU de 125 mm





Rodas traseiras ajustáveis em 360 graus

Agarramento ergonômico antiderrapante

Proteção lateral contra impactos

Dobrável



	WK602320 1 / 001-048.000
	300 KG
	910 X 610 MM
	890 MM
	8 424835 009595

Rasqueta pintura

Paint scraper

Raspadeira pintura

Cuerpo de ABS

Agarre ergonómico antideslizante

Incluye hoja de corte

ABS body

Ergonomic non-slip grip

Includes cutting blade

Corpo de ABS

Agarramento ergonómico antiderrapante

Inclui lâmina de corte



	WK600500 10 / 010-001.400
	120 MM
	40 X 19 MM
	0.4 MM
	8 424835 002190

Rasqueta pintura

Paint scraper

Raspadeira pintura

Cuerpo de ABS

Agarre ergonómico antideslizante

Incluye hoja de corte

ABS body

Ergonomic non-slip grip

Includes cutting blade

Corpo de ABS

Agarramento ergonómico antiderrapante

Inclui lâmina de corte



	WK600510 10 / 005-002.600
	160 MM
	90 X 18 MM
	0.5 MM
	8 424835 002183

Hoja rasqueta

Scraper blade

Lâmina raspadeira

Cuerpo de acero carbono

Un solo filo

Carbon steel body

Single-edged

Corpo de aço carbono

Um só gume

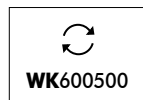

	WK300040 6 / 006-000.900
	40 X 19 MM
	0.4 MM
PCS	5
	8 424835 002909

Hoja rasqueta

Scraper blade

Lâmina raspadeira

Cuerpo de acero carbono

Doble filo

Carbon steel body

Double-edged

Corpo de aço carbono

Duplo gume

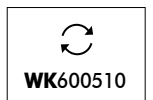

	WK300050 6 / 006-001.000
	90 X 18 MM
	0.5 MM
PCS	5
	8 424835 003272

Rasqueta pintura

Paint scraper

Raspadeira pintura

Cuerpo de aluminio

Mango de ABS

Agarre ergonómico antideslizante

Tope de golpe metálico

Incluye hoja de corte

Aluminium body

ABS handle

Ergonomic non-slip grip

Metallic hit end

Includes cutting blade

Corpo de alumínio





Cabo de ABS

Agarramento ergonômico antiderrapante

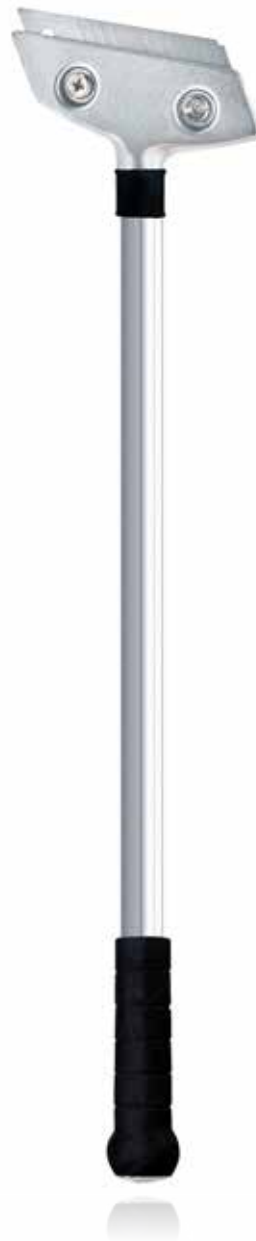
Tope de golpe metálico

Inclui lâmina de corte



	WK600520 5 / 001-003.600	WK600530 5 / 001-005.600
	300 MM	600 MM
	100 X 18 MM	100 X 18 MM
	0.6 MM	0.6 MM
	8 424835 002336	8 424835 001919

Rasqueta pintura

Paint scraper

Raspadeira pintura

Cuerpo de acero forjado

Mango de ABS

Agarre ergonómico

Incluye hoja de corte

Forged steel body

ABS handle

Ergonomic grip

Includes cutting blade

Corpo de aço forjado

Cabo de ABS

Agarramento ergonómico

Inclui lâmina de corte



⊙
|
WK600470
6 / 001-005.800

↕
240 MM

⊠
25 X 25 X 25 MM

∨
/
2.0 MM

|||||
8 424835 004651

Rasqueta pintura

Paint scraper

Raspadeira pintura

Cuerpo de acero forjado

Mango de ABS

Agarre ergonómico

Incluye hoja de corte

Forged steel body

ABS handle

Ergonomic grip

Includes cutting blade

Corpo de aço forjado

Cabo de ABS

Agarramento ergonómico

Inclui lâmina de corte



⊙
|
WK600480
6 / 001-006.800

↕
250 MM

⊠
52 X 8 MM

∨
/
2.0 MM

|||||
8 424835 004644

Rasqueta pintura

Paint scraper

Raspadeira pintura

Cuerpo de acero forjado

Mango de ABS

Mango auxiliar

Agarre ergonómico

Incluye hoja de corte

Forged steel body

ABS handle

Auxiliary handle

Ergonomic grip

Includes cutting blade

Corpo de aço forjado

Cabo de ABS

Cabo auxiliar

Agarramento ergonómico

Inclui lâmina de corte



⊙
|
WK600490
6 / 001-007.800

↕
290 MM

⊠
65 X 8 MM

∨
/
2.0 MM

|||||
8 424835 001384

Hoja rasqueta Scraper blade Lâmina raspadeira

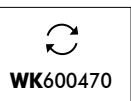

Cuerpo de acero carbono
Triple filo

Carbon steel body
Triple-edged

Corpo de aço carbono
Triplô gume



	WK300010 6 / 001-002.200
	25 X 25 X 25 MM
	2.0 MM
	8 424835 002879

Hoja rasqueta Scraper blade Lâmina raspadeira

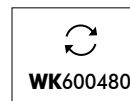

Cuerpo de acero carbono
Doble filo

Carbon steel body
Double-edged

Corpo de aço carbono
Duplo gume



	WK300020 6 / 001-003.200
	52 X 8 MM
	2.0 MM
	8 424835 002886

Hoja rasqueta Scraper blade Lâmina raspadeira

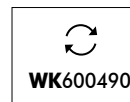

Cuerpo de acero carbono
Doble filo

Carbon steel body
Double-edged

Corpo de aço carbono
Duplo gume



	WK300030 6 / 001-003.600
	65 X 8 MM
	2.0 MM
	8 424835 002893

Cepillo bordes paneles-placas yeso

Drywall panel-board edge plane

Plaina bordas painéis-placas gesso

Cuerpo de ABS

Agarre ergonómico

Incluye 2 hojas de corte

ABS body

Ergonomic grip

Includes 2 cutting blades

Corpo de ABS

Agarramento ergonômico

Inclui 2 lâminas de corte



	WK602480 60 / 001-004.400
	240 MM
	23 X 23 / 53 X 19 MM
	9.5-15 MM
	22.5° / 45°
	8 424835 010034

Cortador horizontal-circular paneles-placas yeso

Drywall panel-board horizontal-circular cutter

Cortador horizontal-circular painéis-placas gesso

Cuerpo de acero y ABS

Agarre ergonómico

Medición en centímetros

Incluye disco de corte

Steel and ABS body

Ergonomic grip

Centimeter measurement

Includes cutting disc

Corpo de aço e ABS

Agarramento ergonômico

Medição em centímetros

Inclui disco de corte



	WK602490 12 / 001-016.000
	700 MM
	600 MM
	1200 MM
	10 MM
	8 424835 010041

Nivel rectangular

Rectangular level

Nível retangular

Cuerpo de aluminio

Nivelado horizontal, vertical y ajustable 0-90°

Protección lateral contra impactos

Magnético

Medición en centímetros

Aluminium body

Horizontal, vertical and adjustable 0-90° levelling

Lateral protection against impacts

Magnetic

Centimeter measuring

Corpo de alumínio

Nivelado horizontal, vertical e ajustável 0-90°

Proteção lateral contra impactos

Magnético

Medição em centímetros



⊙ 	WK602170 10 / 001-007.600	WK602180 10 / 001-008.600	WK602190 10 / 001-009.6000
↕	600 MM	800 MM	1000 MM
⊕	0.5 MM/M	0.5 MM/M	0.5 MM/M
📄	CLASS-I	CLASS-I	CLASS-I
	8 424835 009144	8 424835 009151	8 424835 009168

Nivel ala avión

Plane wing level

Nível asa avião

Cuerpo de aluminio

Nivelado horizontal, vertical y 45°

Protección lateral contra impactos

Medición en centímetros

Aluminium body

Horizontal, vertical and 45° levelling

Lateral protection against impacts

Centimeter measuring

Corpo de alumínio

Nivelado horizontal, vertical e 45°

Proteção lateral contra impactos

Medição em centímetros



⊙ 	WK602300 10 / 001-012.000
↕	600 MM
⊕	0.5 MM/M
📄	CLASS-I
	8 424835 009533

Rascador yeso

Drywall scraper





Rascador gesso

Cuerpo de acero carbono
Juntas con soldadura TIG
Agarre ergonómico antideslizante

Carbon steel body
TIG welding joints
Ergonomic non-slip grip

Corpo de aço carbono
Juntas com soldadura TIG
Agarramento ergonômico antiderrapante



	WK600540 10 / 001-006.200
	285 MM
	150 MM
	9
	8 424835 001070

Rascador yeso

Drywall scraper





Rascador gesso

Cuerpo de acero carbono
Juntas con soldadura TIG
Mango ergonómico

Carbon steel body
TIG welding joints
Ergonomic handle

Corpo de aço carbono
Juntas com soldadura TIG
Cabo ergonômico



	WK600550 10 / 001-012.000
	450 MM
	90 MM
	9
	8 424835 002589

Tiralíneas

Chalk line

Tira-linhas

Cuerpo de ABS

Manivela plegable

Incluye polvo tiralíneas de 50 gramos

ABS body

Foldable handle

Includes 50 gram chalk line powder

Corpo de ABS

Manivela dobrável

Inclui pó tira-linhas de 50 gramos



○ ┃	WK600200 6 / 001-004.000
↑ ↓	30 M
	8 424835 003722

Tiralíneas multiplicador

Multiplier chalk line

Tira-linhas multiplicador

Cuerpo de ABS

Manivela plegable

Función de enrollado rápido

Incluye polvo tiralíneas de 50 gramos

ABS body

Foldable handle

Fast speed rolling function

Includes 50 gram chalk line powder

Corpo de ABS

Manivela dobrável

Função de enrolado rápido

Inclui pó tira-linhas de 50 gramos



○ ┃	WK600210 6 / 001-005.200
↑ ↓	30 M
	8 424835 003739

Maza goma
Rubber mallet
 Martelo borracha

Cabecal de goma
Mango de fibra
Agarre ergonómico antideslizante

Rubber head
 Fiber handle
 Ergonomic non-slip grip

Cabeçal de borracha
 Cabo de fibra
 Agarramento ergonômico antiderrapante



⊙ I	WK601670 36 / 001-003.600	WK601680 24 / 001-004.400	WK601690 24 / 001-005.800
↑ ↓	310 MM	340 MM	380 MM
⚖	340 GR	450 GR	680 GR
⊘	80 X 50 MM	90 X 55 MM	100 X 60 MM
	8 424835 006679	8 424835 006686	8 424835 006693

Maceta
Club hammer
 Maceta

Cabecal de acero carbono forjado
Cabecal tratado térmicamente para durezas extremas
Mango de fibra
Agarre ergonómico antideslizante
Unión cabezal y mango reforzada con sistema de fijación eterna de nylon

Forged carbon steel head
 Heat treated head for extreme hardness
 Fiber handle
 Ergonomic non-slip grip
 Head and handle union reinforced with eternal nylon fixing system

Cabeçal de aço carbono forjado
 Cabeçal tratada termicamente para dureza extrema
 Cabo de fibra
 Agarramento ergonômico antiderrapante
 União cabeçal e cabo reforçada com sistema de fixação eterna de nylon



⊙ I	WK601730 12 / 001-006.000	WK601740 12 / 001-007.000	WK601750 12 / 001-008.000
↑ ↓	265 MM	265 MM	265 MM
⚖	1000 GR	1250 GR	1500 GR
⊘	94 X 40 X 40 MM	98 X 44 X 44 MM	108 X 46 X 46 MM
	8 424835 007300	8 424835 007317	8 424835 007324

Maceta

Club hammer

Maceta

Cabezal de acero carbono forjado

Cabezal tratado térmicamente para durezas extremas

Mango de fibra

Agarre ergonómico antideslizante

Unión cabezal y mango reforzada con sistema de fijación eterna de nylon

Forged carbon steel head

Heat treated head for extreme hardness

Fiber handle

Ergonomic non-slip grip

Head and handle union reinforced with eternal nylon fixing system

Cabeçal de aço carbono forjado

Cabeçal tratada termicamente para dureza extrema

Cabo de fibra

Agarramento ergonômico antiderrapante

União cabeçal e cabo reforçada com sistema de fixação eterna de nylon



	WK602390 6 / 001-020.000	WK602400 4 / 001-028.000
	910 MM	910 MM
	3 KG	5 KG
	140 X 55 X 55 MM	160 X 67 X 67 MM
	8 424835 009755	8 424835 009762

Pistola grapadora

Stapler gun

Pistola agrafadora

Cuerpo de acero forjado y acero inoxidable

Agarre ergonómico

Función de regulación de fuerza de impacto

Función de liberación rápida de atascos

Clip de seguridad de palanca

Incluye 200 grapas

Forged steel and stainless-steel body

Ergonomic grip

Impact power adjustment function

Quick jam release function

Lever safety clip

Includes 200 staples

Corpo de aço forjado e aço inoxidável

Agarramento ergonômico

Função de regulação de força de impacto

Função liberação rápida de atascos

Clipe de segurança de alavanca

Inclui 200 agrafos

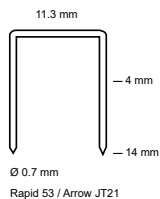

Pistola grapadora-clavadora

Stapler-nailer gun

Pistola agrafadora-pregadora

Cuerpo de acero forjado y acero inoxidable

Agarre ergonómico

Función de regulación de fuerza de impacto

Función de liberación rápida de atascos

Clip de seguridad de palanca

Incluye 200 grapas, 200 grapas U y 200 clavos

Forged steel and stainless-steel body

Ergonomic grip

Impact power adjustment function

Quick jam release function

Lever safety clip

Includes 200 staples, 200 U staples and 200 nails

Corpo de aço forjado e aço inoxidável

Agarramento ergonômico

Função de regulação de força de impacto

Função liberação rápida de atascos

Clipe de segurança de alavanca

Inclui 200 agrafos, 200 agrafos U e 200 pregos

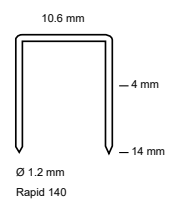
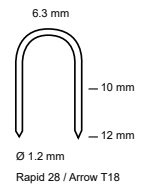
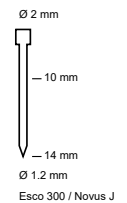

	WK601790 12 / 001-006.400
	0.7 MM
	11.3 MM
	4 - 14 MM
	100
	TÜV GS
	8 424835 007614

	WK601800 12 / 001-007.200
	1.2 MM
	10.6 MM
	4 - 14 MM
	1.2 MM
	6.3 MM
	10 - 12 MM
	1.2 MM
	10 - 14 MM
	100
	TÜV GS
	8 424835 007621

Pistola grapadora-clavadora

Stapler-nailer gun

Pistola agrafadora-pregadora

Cuerpo de acero forjado y acero inoxidable

Agarre ergonómico antideslizante

Función de regulación de fuerza de impacto

Función de liberación rápida de atascos

Clip de seguridad de palanca

Clip de sujeción para el cinturón

Forged steel and stainless-steel body

Ergonomic non-slip grip

Impact power adjustment function

Quick jam release function

Lever safety clip

Fastening belt clip

Corpo de aço forjado e aço inoxidável

Agarramento ergonômico antiderrapante

Função de regulação de força de impacto

Função liberação rápida de atascos

Clipe de segurança de alavanca

Clipe de sujeição para o cinto

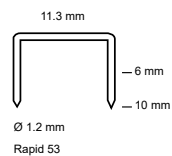
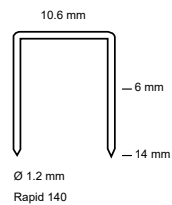
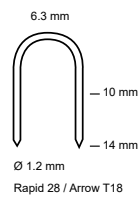
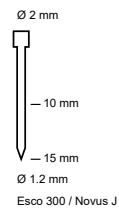

⊙ I	WK601810 12 / 001-014.000
□∅	1.2 MM
□↔	10.6 MM
□↑↓	6 - 14 MM
∩∅	1.2 MM
∩↔	6.3 MM
∩↑↓	10 - 14 MM
□∅	1.2 MM
□↔	11.3 MM
□↑↓	6 - 10 MM
∅	1.2 MM
↑↓	10 - 15 MM
☰	120
☰	TÜV GS
	8 424835 007638

Escaleras y plataformas
Ladders and platforms
Escadas e plataformas



Escalera multiuso

Multipurpose ladder

Escada multiuso

Cuerpo de aluminio

Tacos de goma

Fácilmente transportable

Plegable

Aluminium body

Rubber blocks

Easily transportable

Foldable

Corpo de alumínio

Blocos de borracha

Facilmente transportável

Dobrável



Plataforma escalera multiuso

Multipurpose ladder platform

Plataforma escada multiuso

Cuerpo de acero galvanizado

Fácilmente montable

Antideslizante

Galvanized Steel body

Easily mountable









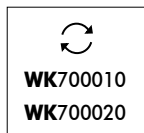



Non-slip







Corpo de aço galvanizado

Facilmente montável

Anti-deslizante



	WK700010 1 / 001-095.000	WK700020 1 / 001-118.000
	150 KG	150 KG
	372 CM	472 CM
	102 CM	127 CM
	180 CM	226 CM
	102 CM	127 CM
	4 X 3	4 X 4
	26 CM	26 CM
	35 CM	35 CM
	1.2 MM	1.2 MM
	EN 131-4	EN 131-4
	8 424835 000646	8 424835 000950

	WK700070 10 / 001-012.000	WK700080 10 / 001-015.000
	150 KG	150 KG
	150 CM	205 CM
	32 CM	32 CM
	1 MM	1 MM
	8 424835 006280	8 424835 006297

Escalera telescópica multiuso

Telescopic multipurpose ladder

Escada telescópica multiuso

Cuerpo de aluminio

Tacos de goma

Fácilmente transportable

Extensible

Plegable

Aluminium body

Rubber blocks

Easily transportable

Extendable

Foldable

Corpo de alumínio













Blocos de borracha

Fácilmente transportável

Extensível

Dobrável



	WK700110 1 / 001-126.000	WK700120 1 / 001-148.000
	150 KG	150 KG
	398 CM	510 CM
	120 CM	148 CM
	194 CM	247 CM
	102 CM	127 CM
	2 X 4+4	2 X 5+5
	28 CM	28 CM
	35 CM	35 CM
	1.2 / 1.5 MM	1.2 / 1.5 MM
	EN 131-4	EN 131-4
	8 424835 006808	8 424835 006792

Plataforma

Platform

Plataforma

Cuerpo de aluminio

Tacos de goma

Fácilmente transportable

Plegable

Antideslizante

Aluminium body

Rubber blocks

Easily transportable

Foldable

Non-slip

Corpo de alumínio

Blocos de borracha

Facilmente transportável

Dobrável

Anti-deslizante



	WK700160 1 / 001-075.000	WK700170 1 / 001-080.000
	150 KG	150 KG
	75 CM	75 CM
	75 X 45 CM	100 X 45 CM
	1.5 MM	1.5 MM
	EN 14183	EN 14183
	8 424835 010072	8 424835 010089

Escalera ancha

Wide ladder

Escada larga

Cuerpo de acero carbono

Asa acolchada de caucho

Tacos de goma

Fácilmente transportable

Plegable

Antideslizante

Carbon steel body

Rubber padded handle

Rubber blocks

Easily transportable

Foldable

Non-slip

Corpo de aço carbono

Alça acolchoada de borracha

Blocos de borracha

Facilmente transportável

Dobrável

Anti-deslizante



Escalera telescópica

Telescopic ladder

Escada telescópica

Cuerpo de aluminio

Tacos de goma

Fácilmente transportable

Extensible

Función de cierre suave

Aluminium body

Rubber blocks

Easily transportable

Extendable

Soft close function

Corpo de alumínio

Blocos de borracha

Facilmente transportável

Extensível

Função de cierre suave



	WK700090 4 / 001-030.000	WK700100 4 / 001-036.000
	150 KG	150 KG
	89 CM	110 CM
	46 CM	46 CM
	2	3
	48 CM	70 CM
	26 X 38 CM	26 X 38 CM
	1.2 MM	1.2 MM
	EN 14183	EN 14183
	8 424835 006167	8 424835 006198

	WK700140 1 / 001-111.000	WK700150 1 / 001-131.000
	150 KG	150 KG
	85-320 CM	91-380 CM
	47 / 81 CM	47 / 86 CM
	10	12
	29 CM	29 CM
	1.3 MM	1.3 MM
	EN 131-6	EN 131-6
	8 424835 009618	8 424835 009625

Protección y seguridad
Protection and safety
Proteção e segurança



Mascarilla

Mask

Máscara

EN 149

Cuerpo de polipropileno
Clip nasal de acero inoxidable
Almohadilla interior
Bandas elásticas

Polypropylene body
 Stainless-steel nose clip
 Inner pad
 Elastic bands

Corpo de polipropileno
 Clipe nasal de aço inoxidável
 Almofadinha interior
 Bandas elásticas



	WK100130 20 / 001-004.600
	FFP1
	3
	4 X TLV
PCS	10
	CE CAT-II
	8 424835 001278

Mascarilla

Mask

Máscara

EN 149

Cuerpo de polipropileno
Válvula de exhalación
Clip nasal de acero inoxidable
Almohadilla interior
Bandas elásticas

Polypropylene body
 Exhalation valve
 Stainless-steel nose clip
 Inner pad
 Elastic bands

Corpo de polipropileno
 Válvula de exalação
 Clipe nasal de aço inoxidável
 Almofadinha interior
 Bandas elásticas



	WK100150 20 / 001-006.600	WK100160 20 / 001-007.200
	FFP1	FFP2
	3	3
	4 X TLV	12 X TLV
PCS	10	10
	CE CAT-II	CE CAT-II
	8 424835 004705	8 424835 004699

Mascarilla**Mask**

Máscara

Cuerpo de polipropileno
Válvula de exhalación
Capa intermedia de carbón activo
Clip nasal de acero inoxidable
Almohadilla interior
Bandas elásticas

Polypropylene body
 Exhalation valve
 Intermediate layer of activated carbon
 Stainless-steel nose clip
 Inner pad
 Elastic bands

Corpo de polipropileno
 Válvula de exalação
 Camada intermédia de carvão ativado
 Clipe nasal de aço inoxidável
 Almofadinha interior
 Bandas elásticas



	WK100200 20 / 001-007.600
	FFP2
	4
	12 X TLV
PCS	10
	CE CAT-II
	8 424835 004675

Mascarilla

Mask

Máscara







EN 149

- Cuerpo de polipropileno**
- Válvula de exhalación**
- Clip nasal de acero inoxidable**
- Almohadilla interior**
- Acolchado interior**
- Bandas anchas elásticas y ajustables**

- Polypropylene body
- Exhalation valve
- Stainless-steel nose clip
- Inner pad
- Interior padded
- Wide elastic and adjustable bands

- Corpo de polipropileno
- Válvula de exalação
- Clipe nasal de aço inoxidável
- Almofadinha interior
- Acolchoado interior
- Bandas largas elásticas e ajustáveis



	WK100580 40 / 001-009.200
	FFP3
	3
	50 X TLV
PCS	5
	CE CAT-III
	8 424835 007928

Mascarilla

Mask

Máscara

Cuerpo de polipropileno

Válvula de exhalación

Capa intermedia de carbón activo

Clip nasal de acero inoxidable

Almohadilla interior

Acolchado interior

Bandas anchas elásticas y ajustables

Polypropylene body

Exhalation valve

Intermediate layer of activated carbon

Stainless-steel nose clip

Inner pad

Interior padded

Wide elastic and adjustable bands

Corpo de polipropileno

Válvula de exalação

Camada intermédia de carvão ativado

Clipe nasal de aço inoxidável

Almofadainha interior

Acolchoado interior

Bandas largas elásticas e ajustáveis



	WK100690 40 / 001-010.000
	FFP3
	4
	50 X TLV
PCS	5
	CE CAT-III
	8 424835 007935

Buzo desechable

Disposable overall

Macação descartável

Cuerpo de polipropileno

Transpirable e impermeable

Costuras termoselladas

Cierre con cremallera

Polypropylene body

Breathable and waterproof

Thermo-sealed seams

Zipper closing





Corpo de polipropileno

Transpirável e impermeável

Costuras termoseladas

Fechamento com zíper



	WK100750 50 / 010-002.800	WK100760 50 / 010-002.800	WK100770 50 / 010-002.800
	55 GR/M ²	55 GR/M ²	55 GR/M ²
	M	L	XL
	CE CAT-I	CE CAT-I	CE CAT-I
	8 424835 003081	8 424835 003050	8 424835 003661

Buzo desechable

Disposable overall

Macação descartável

Cuerpo de polipropileno y polietileno

Transpirable e impermeable

Costuras termoselladas

Cierre con cremallera

Protección contra polvo; partículas sólidas aéreas (tipo 5)

Protección contra líquidos; ligeras salpicaduras líquidas (tipo 6)

Polypropylene and polyethylene body

Breathable and waterproof

Thermo-sealed seams

Zipper closing

Dust protection; solid airborne particles (type 5)

Liquid protection; light liquid splashes (type 6)

Corpo de polipropileno e polietileno

Transpirável e impermeável

Costuras termoseladas

Fechamento com zíper

Proteção contra pó; partículas sólidas aéreas (tipo 5)

Proteção contra líquidos; leves salpicos líquidos (tipo 6)



EN 13034

EN ISO 13982-1

EN 1073-2

EN 1149-5

EN 14126



TYPE 5B
TYPE 6B



CLASS 2



	WK100420 50 / 010-003.800	WK100430 50 / 010-003.800	WK100440 50 / 010-003.800
	55 GR/M ²	55 GR/M ²	55 GR/M ²
	M	L	XL
	CE CAT-III	CE CAT-III	CE CAT-III
	8 424835 003944	8 424835 003791	8 424835 001490

Pantalón

Trouser

Calça

Cuerpo de 65% poliéster y 35% algodón

Refuerzos de doble costura

Fondo blanco, con bolsillos y costuras en negro

Cierre con cremallera y botón - Cintura elástica

Transpirable

Incluye 6 bolsillos

65% polyester and 35% cotton body

Double-stitched gussets

White background, with black pockets and stitchings

Zipper and button closing - Elastic waist

Breathable

Includes 6 pockets

Corpo de 65% poliéster e 35% algodão

Reforços de costura dupla

Fundo branco, com bolsos e costuras em preto

Fechamento com zíper e botão - Cintura elástica

Respirável

Inclui 6 bolsos



	WK102870 20 / 001-009.400	WK102880 20 / 001-009.400	WK102890 20 / 001-009.400	WK102900 20 / 001-009.400	WK102910 20 / 001-009.400
	240 GR/M ²	240 GR/M ²	240 GR/M ²	240 GR/M ²	240 GR/M ²
	S	M	L	XL	2XL
	CE CAT-I	CE CAT-I	CE CAT-I	CE CAT-I	CE CAT-I
	8 424835 006839	8 424835 006846	8 424835 006853	8 424835 006860	8 424835 006877

Camiseta

T-shirt

Camiseta

Cuerpo de 65% poliéster y 35% algodón
Refuerzos de doble costura
Fondo blanco, con cuello y puños en negro
Transpirable

Polyester 65% and cotton 35% body
 Double-stitched gussets
 White background, with black collar and cuffs
 Breathable

Corpo de 65% poliéster e 35% algodão
 Reforços de costura dupla
 Fundo branco com pescoço e punhos em preto
 Transpirável



	WK101410 50 / 001-003.600	WK101420 50 / 001-003.600	WK101430 50 / 001-003.600	WK101440 50 / 001-003.600	WK101450 50 / 001-003.600
	180 GR/M ²	180 GR/M ²	180 GR/M ²	180 GR/M ²	180 GR/M ²
	S	M	L	XL	2XL
	CE CAT-I	CE CAT-I	CE CAT-I	CE CAT-I	CE CAT-I
	8 424835 008666	8 424835 008673	8 424835 008680	8 424835 008697	8 424835 008703

Polo

Polo shirt

Polo

Cuerpo de 65% poliéster y 35% algodón
Refuerzos de doble costura
Fondo blanco, con cuello, cierre y puños en negro
Cierre con 3 botones
Transpirable

Polyester 65% and cotton 35% body
 Double-stitched gussets
 White background, with black collar, closing and cuffs
 Closing with 3 buttons
 Breathable

Corpo de 65% poliéster e 35% algodão
 Reforços de costura dupla
 Fundo branco com pescoço e punhos em preto
 Fechamento com 3 botões
 Transpirável



	WK102820 50 / 001-004.400	WK102830 50 / 001-004.400	WK102840 50 / 001-004.400	WK102850 50 / 001-004.400	WK102860 50 / 001-004.400
	180 GR/M ²	180 GR/M ²	180 GR/M ²	180 GR/M ²	180 GR/M ²
	S	M	L	XL	2XL
	CE CAT-I	CE CAT-I	CE CAT-I	CE CAT-I	CE CAT-I
	8 424835 005382	8 424835 005399	8 424835 005405	8 424835 005412	8 424835 005429

Suéter

Sweater





Suéter

Cuerpo de 65% poliéster y 35% algodón
Refuerzos de doble costura
Fondo blanco, con cuello, cintura y puños en negro
Cintura y puños elásticos
Transpirable

Polyester 65% and cotton 35% body
 Double-stitched gussets
 White background, with black collar, waist and cuffs
 Elastic waist and cuffs
 Breathable

Corpo de 65% poliéster e 35% algodão
 Reforços de costura dupla
 Fundo branco, com pescoço, cintura e punhos em preto
 Cintura e punhos elásticos
 Transpirável



	WK101630 20 / 001-010.600	WK101640 20 / 001-010.600	WK101650 20 / 001-010.600	WK101660 20 / 001-010.600	WK101670 20 / 001-010.600
	280 GR/M ²	280 GR/M ²	280 GR/M ²	280 GR/M ²	280 GR/M ²
	S	M	L	XL	2XL
	CE CAT-I	CE CAT-I	CE CAT-I	CE CAT-I	CE CAT-I
	8 424835 008857	8 424835 008864	8 424835 008871	8 424835 008888	8 424835 008895

Chaleco

Vest

Colete

Cuerpo de poliéster 150 Denier

Recubrimiento de PU

Refuerzos de doble costura

Fondo blanco, con cremalleras y forro interior en negro

Cierre con cremallera - Cintura elástica

Incluye 3 bolsillos

Polyester 150 Denier body

PU coating

Double-stitched gussets

White background, with black zippers and inner lining

Zipper closing - Elastic waist

Includes 3 pockets

Corpo de poliéster 150 Denier

Recobrimento de PU

Reforços de costura dupla

Fundo branco com zíperes e forro interno em preto

Fechamento com zíper - Cintura elástica

Inclui 3 bolsos



	WK102920 20 / 001-010.800	WK102930 20 / 001-010.800	WK102940 20 / 001-010.800	WK102950 20 / 001-010.800	WK102960 20 / 001-010.800
	180+140 GR/M ²	180+140 GR/M ²	180+140 GR/M ²	180+140 GR/M ²	180+140 GR/M ²
	S	M	L	XL	2XL
	CE CAT-I	CE CAT-I	CE CAT-I	CE CAT-I	CE CAT-I
	8 424835 006884	8 424835 006891	8 424835 006907	8 424835 006914	8 424835 006921

Chaqueta softshell

Softshell jacket

Jaqueta softshell

Cuerpo de 96% poliéster y 4% spandex

Refuerzos de doble costura

Fondo blanco, con cremalleras y forro interior en negro

Cierre con cremallera - Cintura con ajuste de cordón

Puños con ajuste de velcro

Incluye 2 bolsillos

Polyester 96% and spandex 4% body

Double-stitched gussets

White background, with black zippers and inner lining

Zipper closing - Cord adjustment waist

Velcro adjustment cuffs

Includes 2 pockets

Corpo de 96% poliéster e 4% spandex

Reforços de costura dupla

Fundo branco com zíperes e forro interno em preto

Fechamento com zíper - Cintura com ajuste de cordão

Punhos com ajuste de velcro

Inclui 2 bolsos



	WK101310 20 / 001-017.800	WK101320 20 / 001-017.800	WK101330 20 / 001-017.800	WK101340 20 / 001-017.800	WK101350 20 / 001-017.800
	280 GR/M ²	280 GR/M ²	280 GR/M ²	280 GR/M ²	280 GR/M ²
	S	M	L	XL	2XL
	CE CAT-I	CE CAT-I	CE CAT-I	CE CAT-I	CE CAT-I
	8 424835 003548	8 424835 003616	8 424835 008635	8 424835 008642	8 424835 008659

Guantes nitrilo

Nitrile gloves

Luvas nitrile

Cuerpo de poliéster

Recubrimiento de nitrilo en palma

Sin costuras

Fondo blanco, recubrimiento negro y puño en blanco-negro

Buena resistencia a la abrasión

Puño elástico

Polyester body

Nitrile palm coating

Stitchless

White background, black coating and black-white cuff

Good abrasion resistance

Elastic cuff

Corpo de poliéster

Recobrimento de nitrilo em palma

Sem costuras

Fundo branco, recobrimento preto e punho em preto-branco

Boa resistência à abrasão

Punho elástico

EN 420

EN 388



4 1 2 1 X



	WK101070 120 / 012-000.700	WK101080 120 / 012-000.700	WK100700 120 / 012-000.700
	13	13	13
	M (8)	L (9)	XL (10)
	CE CAT-II	CE CAT-II	CE CAT-II
	8 424835 007133	8 424835 003647	8 424835 003760

Guantes PU

PU gloves

Luvras PU

Cuerpo de poliéster

Recubrimiento de poliuretano en palma y dorso

Sin costuras

Fondo blanco, recubrimiento transparente y puño en blanco

Buena resistencia a la abrasión y al rasgado

Puño elástico

Polyester body

Polyurethane palm and back coating

Stitchless

White background, transparent coating and white cuff

Good abrasion and tear resistance

Elastic cuff

Corpo de poliéster

Recobrimento de poliuretano em palma e dorso

Sem costuras

Fundo branco, recobrimento transparente e punho em branco

Boa resistência à abrasão e ao rasgado

Punho elástico



EN 420

EN 388



3 1 3 1 X

	WK101060 120 / 012-000.700	WK101090 120 / 012-000.700	WK100710 120 / 012-000.700
	13	13	13
	M (8)	L (9)	XL (10)
	CE CAT-II	CE CAT-II	CE CAT-II
	8 424835 007140	8 424835 600037	8 424835 003654

Guantes PU

PU gloves

Luvras PU

Cuerpo de poliéster

Recubrimiento de poliuretano en palma y dorso

Sin costuras

Fondo negro, recubrimiento transparente y puño en negro

Buena resistencia a la abrasión y al rasgado

Puño elástico

Polyester body

Polyurethane palm and back coating

Stitchless

Black background, transparent coating and black cuff

Good abrasion and tear resistance

Elastic cuff

Corpo de poliéster

Recobrimento de poliuretano em palma e dorso

Sem costuras

Fundo preto, recobrimento transparente e punho em preto

Boa resistência à abrasão e ao rasgado

Punho elástico



EN 420

EN 388



3 1 3 1 X

	WK102700 120 / 012-000.700	WK100030 120 / 012-000.700	WK100040 120 / 012-000.700
	13	13	13
	M (8)	L (9)	XL (10)
	CE CAT-II	CE CAT-II	CE CAT-II
	8 424835 007126	8 424835 003609	8 424835 003753

Rodilleras inserción

Insert kneepads





Joelheiras inserção

Cuerpo de EVA y espuma
Impermeable

EVA and foam body
Waterproof

Corpo de EVA e espuma
Impermeável



	WK100010 40 / 001-003.400
	≤ 100 N
	75 GR
	CE CAT-I
	8 424835 003975

Rodilleras

Kneepads

Joelheiras

Cuerpo de PVC y poliéster 600D
Relleno de espuma y aire inyectado
Función antideslizante, antimarca y antirayadura
Impermeable

PVC and 600D polyester body
Filled with foam and injected air
Anti-slip, anti-mark and anti-scratch function
Waterproof







Corpo de PVC e poliéster 600D
Recheado de espuma e ar injetado
Função anti-deslizante, anti-marca e anti-riscadura
Impermeável



EN 14404
EN ISO 13688



1

	WK100290 10 / 001-009.800
	≤ 100 N
	XL
	395 GR
	CE CAT-II
	8 424835 005764

Rodilleras

Kneepads

Joelheiras

Cuerpo de PVC y poliéster 600D

Relleno de espuma, gel y aire inyectado

Función antideslizante, antimarca y antirayadura
Impermeable

PVC and 600D polyester body

Filled with foam, gel and injected air

Anti-slip, anti-mark and anti-scratch function

Waterproof

Corpo de PVC e poliéster 600D

Recheado de espuma, gel e ar injetado

Função antii-deslizante, anti-marca e anti-riscadura







Impermeável



EN 14404
EN ISO 13688



1

	WK100300 10 / 001-010.800
	≤250 N
	XL
	460 GR
	CE CAT-II
	8 424835 000332

Rodilleras

Kneepads

Joelheiras

Cuerpo de PVC y poliéster 600D

Relleno de espuma, gel y aire inyectado

Función antideslizante, antimarca y antirayadura
Impermeable

PVC and 600D polyester body

Filled with foam, gel and injected air

Anti-slip, anti-mark and anti-scratch function

Waterproof

Corpo de PVC e poliéster 600D

Recheado de espuma, gel e ar injetado

Função antii-deslizante, anti-marca e anti-riscadura







Impermeável



EN 14404
EN ISO 13688



1

	WK100340 10 / 001-012.200
	≤250 N
	XL
	585 GR
	CE CAT-II
	8 424835 005757

Traje impermeable

Waterproof suit

Conjunto impermeável

Cuerpo de poliéster 150T
Recubrimiento de PVC
Refuerzos de doble costura
Fondo negro
Cierre con cremallera
Incluye 2 bolsillos y capucha

150T polyester body
PVC coating
Double-stitched gussets
Black background
Zipper closing
Includes 2 pockets and hood

Corpo de poliéster 150T
Recobrimento de PVC
Reforços de costura dupla
Fundo preto
Fechamento com zíper
Inclui 2 bolsos e capuz



	WK100350 20 / 001-007.400	WK100360 20 / 001-007.400	WK100370 20 / 001-007.400	WK100380 20 / 001-007.400	WK100390 20 / 001-007.400
	0.16 MM	0.16 MM	0.16 MM	0.16 MM	0.16 MM
	S	M	L	XL	2XL
	CE CAT-I	CE CAT-I	CE CAT-I	CE CAT-I	CE CAT-I
	8 424835 006822	8 424835 006556	8 424835 006563	8 424835 006570	8 424835 006587

Traje impermeable

Waterproof suit

Conjunto impermeável

Cuerpo de poliuretano - Recubrimiento de PVC
Refuerzos de doble costura
Fondo negro
Solapa adicional con cierre de corchete
Cierre con cremallera
Incluye 2 bolsillos y capucha

Polyurethane body - PVC coating
Double-stitched gussets
Black background
Additional flap with rivet button closing
Zipper closing
Includes 2 pockets and hood

Corpo de poliuretano - Recobrimento de PVC
Reforços de costura dupla
Fundo preto
Lapela adicional com fechamento de colchete
Fechamento com zíper
Inclui 2 bolsos e capuz



	WK102720 20 / 001-019.800	WK102730 20 / 001-019.800	WK102740 20 / 001-019.800	WK102750 20 / 001-019.800	WK102760 20 / 001-019.800
	0.40MM	0.40MM	0.40MM	0.40MM	0.40MM
	S	M	L	XL	2XL
	CE CAT-I	CE CAT-I	CE CAT-I	CE CAT-I	CE CAT-I
	8 424835 006990	8 424835 007003	8 424835 007010	8 424835 007027	8 424835 007034

Chaleco alta visibilidad

High visibility vest

Colete alta visibilidade

Cuerpo de poliéster

Cierre con velcro horizontal

Fondo amarillo fluorescente con ribete en negro

Transpirable

Polyester body

Horizontal velcro closing

Yellow fluorescent background with black trim

Breathable

Corpo de poliéster

Fechamento com velcro horizontal

Fundo amarelo fluorescente com rebordo preto

Transpirável

EN 340
EN ISO 20471

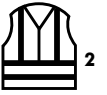

	WK101270 100 / 010-001.600	WK101280 100 / 010-001.600	WK101290 100 / 010-001.600
	120 GR/M ²	120 GR/M ²	120 GR/M ²
	XS	M	XL
	CE CAT-II	CE CAT-II	CE CAT-II
	8 424835 006259	8 424835 006266	8 424835 006273

Gafas Glasses Óculos





EN 166

Lentes de policarbonato
Montura y patillas de policarbonato
Sistema de ventilación
Compatible con gafas graduadas

Polycarbonate lenses
Polycarbonate frame and side-pieces
Ventilation system
Compatible with prescription glasses

Lentes de policarbonato
Armação e hastes de policarbonato
Sistema de ventilação
Compatível com óculos graduados



	WK100820 100 / 010-001.600
	F
	1
	CE CAT-II
	8 424835 004187

Gafas Glasses Óculos





EN 166

Lentes de policarbonato
Montura y patillas de nylon
Patillas extensibles

Polycarbonate lenses
Nylon frame and side-pieces
Extendable side-pieces

Lentes de policarbonato
Armação e hastes de nylon
Hastes extensíveis



	WK101550 100 / 010-001.600
	S
	1
	CE CAT-II
	8 424835 004194

Gafas Goggles Óculos





EN 166

Lentes de policarbonato
Montura de PVC
Banda elástica ajustable
Sistema de ventilación
Compatible con gafas graduadas

Polycarbonate lenses
PVC frame
Elastic adjustable band
Ventilation system
Compatible with prescription glasses

Lentes de policarbonato
Armação de PVC
Banda elástica ajustável
Sistema de ventilação
Compatível com óculos graduados



	WK102710 100 / 001-005.200
	F
	1
	CE CAT-II
	8 424835 000295

Protector auditivo

Hearing protector

Protetor auditivo

EN 352-1

Cuerpo de ABS

Banda de acero forjado y PVC

Flexible y extensible

Plegable

Ligero

ABS body

Forged steel and PVC headband

Flexible and extensible

Foldable

Light

Corpo de ABS

Banda de aço forjado e PVC

Flexível e extensível

Dobrável

Leve



Protector auditivo

Hearing protector

Protetor auditivo

EN 352-1

Cuerpo de ABS

Banda de acero forjado y PVC

Flexible y extensible

Ligero

ABS body

Forged steel and PVC headband

Flexible and extensible

Light

Corpo de ABS

Banda de aço forjado e PVC

Flexível e extensível

Leve



	WK101300 20 / 001-005.600
	25 dB
	M
	CE CAT-III
	8 424835 005825

	WK101620 20 / 001-007.800
	29 dB
	M
	CE CAT-III
	8 424835 005900

Casco

Helmet

Capacete

EN 397

Cuerpo de HDPE

Estabilizador de rayos ultravioleta

Resistente a la perforación

Ajuste del arnés

Sistema de ventilación

HDPE body

Ultraviolet rays stabilizer

Penetration resistance

Harness adjustment

Ventilation system

Corpo de HDPE

Estabilizador de raios ultravioleta

Resistente à perfuração

Ajuste do arnés

Sistema de ventilação



	WK100180 ○ 20 / 001-006.200	WK100400 ● 20 / 001-006.200	WK100410 ● 20 / 001-006.200
	≤ 5 kN	≤ 5 kN	≤ 5 kN
	≥ 5 S	≥ 5 S	≥ 5 S
	-10-50° C	-10-50° C	-10-50° C
	54-63 CM	54-63 CM	54-63 CM
	CE CAT-II	CE CAT-II	CE CAT-II
	8 424835 006150	8 424835 001544	8 424835 001551

Cinta amarre

Cam buckle strap

Fita amarração

Cuerpo de poliéster

Hebilla de zinc y aluminio

Agarre ergonómico

Coefficiente de seguridad de capacidad de carga de 2:1

Polyester body

Zinc and aluminium buckle

Ergonomic grip

Load capacity safety coefficient of 2:1

Corpo de poliéster

Fivela de zinc e alumínio

Agarramento ergonômico

Coefficiente de segurança de capacidade de carga 2:1



	WK100510 96 / 001-002.400	WK100520 36 / 001-005.800
	250 KG (daN)	500 KG (daN)
	3 M	4 M
	25 MM	35 MM
PCS	2	2
	TÜV GS	TÜV GS
	8 424835 003135	8 424835 002947

Cinta trincaje

Ratchet tie down

Fita amarração

Cuerpo de poliéster

Hebilla y gancho de acero inoxidable

Agarre ergonómico

Coefficiente de seguridad de capacidad de carga de 2:1

Polyester body

Stainless-steel buckle and hook

Ergonomic grip

Load capacity safety coefficient of 2:1

Corpo de poliéster

Fivela e gancho de aço inoxidável

Agarramento ergonômico

Coefficiente de segurança de capacidade de carga 2:1



	WK100530 54 / 001-003.400	WK100540 42 / 001-004.800	WK100560 24 / 001-006.800	WK100570 20 / 001-009.400	WK100590 10 / 001-014.400
	500 KG (daN)	1000 KG (daN)	2000 KG (daN)	3000 KG (daN)	5000 KG (daN)
	250 KG (daN)	500 KG (daN)	1000 KG (daN)	1500 KG (daN)	2500 KG (daN)
	6 M	6 M	6 M	8 M	10 M
	25 MM	25 MM	35 MM	35 MM	50 MM
	TÜV GS	TÜV GS	TÜV GS	TÜV GS	TÜV GS
	8 424835 005139	8 424835 005832	8 424835 005894	8 424835 006600	8 424835 006594

Filtro cubresuelo

Floor cover

Filtro cobre-chão

Cuerpo de poliéster y algodón

Impermeable y reutilizable

Absorbente de pinturas y líquidos

Antideslizante

Polyester and cotton body

Waterproof and re-usable

Paints and liquids absorbent

Anti-slip

Corpo de poliéster e algodão

Impermeável e reutilizável

Absorvente de pinturas e líquidos

Anti-deslizante



○ 1	WK102980 24 / 001-004.200	WK102970 10 / 001-008.000	WK102670 6 / 001-013.200
↑ ↓	5 M	10 M	20 M
← →	1 M	1 M	1 M
∨ ∧	200 GR/M ²	200 GR/M ²	200 GR/M ²
	8 424835 006037	8 424835 003425	8 424835 002770

Químicos técnicos

Technical chemicals

Químicos técnicos



Transformador óxido

Rust transformer

Transformador óxido

Actúa directamente contra el óxido

Fácil de usar, se aplica con brocha, rodillo, pistola o inmersión

Bajo costo, eficiencia excepcional de cobertura

Acts directly against rust

Easy to use, to be applied by brush, roller, spray or immersion



Low cost, exceptional coverage efficiency

Age diretamente contra o óxido

Fácil de usar, é aplicado por pincel, rolo, spray ou imersão

Baixo custo, cobertura eficiência excepcional



	WK200010 24 / 024-003.500	WK200020 24 / 024-005.600	WK200030 12 / 012-009.000	WK200040 12 / 012-014.400
	125 ML	250 ML	500 ML	1000 ML
	8 424835 001254	8 424835 002503	8 424835 005009	8 424835 010003

Transformador óxido

Rust transformer

Transformador óxido

Actúa directamente contra el óxido

Fácil de usar, se aplica con brocha, rodillo, pistola o inmersión

Bajo costo, eficiencia excepcional de cobertura

Acts directly against rust

Easy to use, to be applied by brush, roller, spray or immersion



Low cost, exceptional coverage efficiency

Age diretamente contra o óxido

Fácil de usar, é aplicado por pincel, rolo, spray ou imersão

Baixo custo, cobertura eficiência excepcional



	WK200060 1 / 001-058.000	WK200070 1 / 001-230.000
	5 L	25 L
	8 424835 000011	8 424835 000028

Expositor y surtido

Display and assortment

Expositor e sortimento

Incluye 7x125 ml, 6x250 ml, 5x500 ml y 4x1000 ml
Incluye 30 trípticos

Includes 7x125 ml, 6x250 ml, 5x500 ml and 4x1000 ml
Includes 30 leaflets

Inclui 7x125 ml, 6x250 ml, 5x500 ml e 4x1000 ml
Inclui 30 trípticos



○ I	WK200230 1 / 001-169.000
↑ ↓	325 MM
← →	390 MM
	8 424835 510008

Expositor

Display

Expositor

Incluye 30 trípticos

Includes 30 leaflets

Inclui 30 trípticos



○ I	WK200080 1 / 001-010.000
↑ ↓	325 MM
← →	390 MM
	8 424835 003845

Surtido expositor

Display assortment

Sortimento expositor

Incluye 7x125 ml, 6x250 ml, 5x500 ml y 4x1000 ml

Includes 7x125 ml, 6x250 ml, 5x500 ml and 4x1000 ml

Inclui 7x125 ml, 6x250 ml, 5x500 ml e 4x1000 ml



○ I	WK200240 1 / 001-166.000
	8 424835 001612

Trípticos

Leaflets

Trípticos













































○ I	WK200090 1 / 001-002.000
PCS	30
	8 424835 003852

Simbología

Symbology

Simbologia

	Referencia Item Referência		Segmentos Segments Segmentos		Diámetro órbita Orbit diameter Diâmetro órbita		Certificación Certification Certificação
	Potencia motor Motor power Potência motor		Viscosidad máxima Maximum viscosity Viscosidade máxima		Posiciones péndulo Slope positions Posições pêndulo		Capas Layers Camadas
	Compresor necesario Necessary compressor Compressor necessário		Consumo aire Air consumption Consumo ar		Capacidad carga cinta Tape load capacity Capacidade carga fita	PCS	Unidades Pieces Unidades
	Airless necesario Necessary airless Airless necessário		Diámetro base Base diameter Diâmetro base		Precisión Precision Precisão	UV	Absorción ultravioleta Ultraviolet absorption Absorção ultravioleta
	Potencia batería Battery power Potência bateria		Diámetro disco Disc diameter Diâmetro disco		Posiciones par Torque positions Posições binário		Clase óptica Optical class Classe ótica
	Carga batería Battery charge Carregamento bateria		Diámetro cable Cable diameter Diâmetro cabo		Par máximo Maximum torque Binário máximo	≡	Protección impactos Impact protection Proteção impactos
	Velocidades Speeds Velocidades		Diámetro manguera Hose diameter Diâmetro mangueira		Taladrado madera Wood drilling Perfuração madeira		Resistencia llamas Flame resistance Resistência chamas
	Medidas hoja Blade sizes Medidas lâmina		Diámetro paso fluido Nozzle diameter Diâmetro passagem fluido		Corte madera Wood cutting Corte madeira		Atenuación media Mean attenuation Atenuação média
	Revoluciones Speed rate Rotações		Diámetro corte Cutting diameter Diâmetro corte		Taladrado metal Metal drilling Perfuração metal		Potencia presión Pressure power Potência pressão
	Velocidad Speed Velocidade		Diámetro cartucho Cartridge diameter Diâmetro cartucho		Corte metal Metal cutting Corte metal		Ratio presión Pressure ratio Ratio pressão
	Impactos Impacts Impactos		Tipo punta/taco Bit/stud type Tipo ponta/taco		Taladrado hormigón Concrete drilling Perfuração betão		Medidas base Base sizes Medidas base
	Graduación Graduation Gradação		Tipo boquilla Tip type Tipo boquilha		Filtro partículas Particles filter Filtro partículas		Medidas hoja Sheet sizes Medidas folha
	Compatibilidad accesorio Accessory compatibility Compatibilidade acessório		Diámetro soporte Support diameter Diâmetro suporte		Clase Class Classe		Capacidad tamaño panel Panel size capacity Capacidade tamanho painel
	Presión succión Vacuum pressure Pressão sucção		Medidas cabezal Head sizes Medidas cabeçal		Peso Weight Peso		Medidas escalón Step measures Medidas degrau
	Presión trabajo Working pressure Pressão trabalho		Tomas corriente Power sockets Tomadas corrente		Capacidad carga Load capacity Capacidade carga		Medidas plataforma Platform sizes Medidas plataforma
	Presión máxima Maximum pressure Pressão máxima		Sincronización Synchronisation Sincronização		Límite carga en U Load limit in U Limite carga em U		Medidas base Base sizes Medidas base
	Potencia máxima Maximum power Potência máxima		Tipo cable Cable type Tipo cabo		Límite carga en línea Load limit in line Limite carga em linha		Medidas hoja Sheet sizes Medidas folha

	Temperatura Temperature Temperatura		Medidas Sizes Medidas		Diámetro clavo Nail diameter Diâmetro prego		Rosca entrada y salida Inlet and outlet thread Rosca entrada e saída
	Color temperatura Temperature colour Cor temperatura		Movimiento Motion Movimento		Largo clavo Nail length Comprimento prego		Rosca entrada Inlet thread Rosca entrada
	Temperatura trabajo Working temperature Temperatura trabalho		Capacidad mezclado Mixing capacity Capacidade misturado		Altura total Total height Altura total		Rosca salida Outlet thread Rosca saída
	Resistencia temperatura Temperature resistance Resistência temperatura		Grosor Thickness Grossura		Altura plegada Folded height Altura plegada		Atornillado Screw Aparafusado
	Ángulo haz Beam angle Ângulo feixe		Capacidad corte Cutting capacity Capacidade corte		Altura A A height Altura A		Capacidad Capacity Capacidade
	Alcance haz Beam reach Escopo feixe		Profundidad atornillado Screw depth Profundidade aparafusado		Altura andamio Scaffold height Altura andaime		Protección máxima Maximum protection Proteção máxima
	Caudal trabajo Working flow Caudal trabalho		Punzado metal Metal punching Punçado metal		Escalones Steps Degraus		Resistencia perforación Perforation resistance Resistência perforação
	Caudal máximo Maximum flow Caudal máximo		Ancho corte Cutting width Largura corte		Distancia escalones Step distance Distância degraus		Caudal aire Air flow Caudal ar
	Ancho total Total width Largura total		Diámetro grapa 1 Staple 1 diameter Diâmetro agrafa 1		Número dientes Teeth number Número dentes		Portabrocas Chuck Bucha
	Ancho hoja Blade width Largura lâmina		Ancho grapa 1 Staple 1 width Largura agrafa 1		Grano Grain Grão		Energía impacto Impact energy Energia impacto
	Largo total Total length Comprimento total		Largo grapa 1 Staple 1 length Comprimento agrafa 1		Púas Spikes Puas		Talla Size Tamanho
	Largo hoja Blade length Comprimento lâmina		Diámetro grapa 2 Staple 2 diameter Diâmetro agrafa 2		Malla Mesh Malha		Lumens Lumens Lumens
	Largo cable Cable length Comprimento cabo		Ancho grapa 2 Staple 2 width Largura agrafa 2		Galga Gauge Galga		Duración LED LED life Duração LED
	Largo cartucho Cartridge length Comprimento cartucho		Largo grapa 2 Staple 2 length Comprimento agrafa 2		Láminas Sheets Lâminas		
	Altura elevación Lifting height Altura elevação		Diámetro grapa 3 Staple 3 diameter Diâmetro agrafa 3		Código barras Barcode Código barras		
	Altura total Total height Altura total		Ancho grapa 3 Staple 3 width Largura agrafa 3		Tecnología LED LED technology Tecnologia LED		
	Largo cerda Bristle length Comprimento cerda		Largo grapa 3 Staple 3 length Comprimento agrafa 3		Medida eje Axis measurement Medida eixo		

Observaciones
Remarks
Observações

**Se reserva el derecho a realizar correcciones
y/o modificaciones sin notificación previa**

Diseñado e impreso en España

Copyright 2023

Werku Tools SA

Reserved the right to make corrections
and/or modifications without prior notice

Designed and printed in Spain

Copyright 2023

Werku Tools SA

Se reserva o direito a realizar correções
e/ou modificações sem notificação prévia

Desenhado e impresso em Espanha

Copyright 2023

Werku Tools SA



Werku Tools SA
Carretera N-VI km 586
E-15176 Oleiros - La Coruña
Spain

T +34 981 648 119
info@werku.com
www.werku.com



8 424835 010751